

MEASUREMENT REPORT

EN 302 502 V2.1.1 WLAN 802.11a/n/ac

Applicant: Compex Systems Pte Ltd
Address: No:9 Harrison Road, Harrison Industrial Building, #05-01,
Singapore 369651

Product: 802.11ac Dual Band Module
Serial Model: WLE600VX, WLE600VX-I
Brand Name: COMPEX
Standards: ETSI EN 302 502 V2.1.1 (2017-03)
Result: Complies
Test Date: June 20 ~ July 11, 2017

Reviewed By : *Jame Yuan*
(Jame Yuan)

Approved By : *Marlin Chen*
(Marlin Chen)



The test results relate only to the samples tested.

The test results shown in the test report are traceable to the national/international standards through the calibration of the equipment and evaluated measurement uncertainty herein.

The test report shall not be reproduced except in full without the written approval of MRT Technology (Suzhou) Co., Ltd.

Revision History

Report No.	Version	Description	Issue Date	Note
1706RSU02405	Rev. 01	Initial report	07-11-2017	Valid

Note: This test report was based on MRT report number 1612RSU02405 and updated the standard EN 302 502 version from v1.2.1 to v2.1.1. Besides the receiver blocking items, there is no any other updated item.

CONTENTS

Description	Page
1. General Information	4
1.1. Applicant.....	4
1.2. Manufacturer	4
1.3. Testing Facility	4
1.4. Feature of Equipment under Test.....	5
1.5. Product Specification Subjective	5
1.6. Operation Frequency / Channel List	5
1.7. Description of Available Antennas.....	6
1.8. Description of Antenna RF Port	6
1.9. Standards Applicable for Testing.....	6
2. Test Summary	7
3. Receiver Blocking	8
3.1. Limit.....	8
3.2. Test Setup	8
3.3. Test Procedure	8
3.4. Test Result.....	9
4. Measurement Uncertainty	12
5. List of Measuring Instrument	13
6. Appendix - Original Report	14

1. General Information

1.1. Applicant

Compex Systems Pte Ltd

No:9 Harrison Road, Harrison Industrial Building, #05-01, Singapore 369651

1.2. Manufacturer

Compex Systems Pte Ltd

No:9 Harrison Road, Harrison Industrial Building, #05-01, Singapore 369651

1.3. Testing Facility

Test Site

MRT Technology (Suzhou) Co., Ltd

Test Site Location

D8 Building, No.2 Tian'edang Rd., Wuzhong Economic Development Zone, Suzhou, China

Test Facility / Accreditations

Measurements were performed at MRT Laboratory located in Tian'edang Rd., Suzhou, China

- MRT facility is a FCC registered (MRT Reg. No. 809388) test facility with the site description report on file and has met all the requirements specified in Section 2.948 of the FCC Rules.
- MRT facility is an IC registered (MRT Reg. No. 11384A-1) test laboratory with the site description on file at Industry Canada.
- MRT facility is a VCCI registered (R-4179, G-814, C-4664, T-2206) test laboratory with the site description on file at VCCI Council.
- MRT Lab is accredited to ISO 17025 by the American Association for Laboratory Accreditation (A2LA) under the American Association for Laboratory Accreditation Program (A2LA Cert. No. 3628.01) in EMC, Telecommunications and Radio testing for FCC, Industry Canada, EU and TELEC Rules.



1.4. Feature of Equipment under Test

Product Name:	802.11ac Dual Band Module
Model No :	WLE600VX, WLE600VX-I
Brand Name:	COMPEX
Frequency Range	802.11a/b/g/n/ac

Note: The difference of models is for different marketing requirement.

1.5. Product Specification Subjective

Frequency Range	802.11a /n-HT20/ac-VHT20: 5745 ~ 5825MHz
Channel Number	802.11a/n-HT20/ac-VHT20: 5
Type of Modulation	802.11a/n/ac: OFDM
Data Rate	802.11a: 6/9/12/18/24/36/48/54Mbps 802.11n: up to 300Mbps 802.11ac: up to 866.6Mbps

1.6. Operation Frequency / Channel List

802.11a/n-HT20/ac-VHT20

Channel	Frequency	Channel	Frequency	Channel	Frequency
149	5745 MHz	153	5765 MHz	157	5785 MHz
161	5805 MHz	165	5825 MHz	N/A	N/A

1.7. Description of Available Antennas

Antenna No.	Manufacturer	Tx Paths	Max Directional Gain (dBi)
Dipole Antenna 1#	Kunshan Wavelink Electronic Co., Ltd.	2	2.4GHz: 2.0, 5GHz: 2.0
Dipole Antenna 2#	Smart Ant Inc	2	2.4GHz: 4.5, 5GHz: 7.0
PCB Antenna 3#	TAOGLAS Inc	2	2.4GHz: 4.5, 5GHz: 6.7
PCB Antenna 4#	Compex Systems Pte Ltd	2	2.4GHz: 5.0, 5GHz: 5.0
PCB Antenna 5#	Compex Systems Pte Ltd	2	2.4GHz: 5.0, 5GHz: 5.0

Note: We selected the dipole antenna 2# and PCB antenna 3# for all radiated emission testing.

1.8. Description of Antenna RF Port

--	2.4/5GHz Antenna RF Port	
	2.4/5GHz	2.4/5GHz
Software Control Port	Ant 0	Ant 1

Antenna RF Port Plot



The photograph shows a rectangular metal component with a gold-plated edge connector at the top. At the bottom, there are two circular ports. The left port is labeled 'ANT 1' and the right port is labeled 'ANT 0' in red text. The component is placed on a blue textured surface.

1.9. Standards Applicable for Testing

The EUT complies with the requirements of ETSI EN 302 502 V2.1.1.

2. Test Summary

Clause EN 302 502	Test Parameter	Result (Pass/Fail)	Remark
4.2.7	Receiver Blocking	Pass	--

3. Receiver Blocking

3.1. Limit

While maintaining the minimum performance criteria as defined in clause 4.2.7.3, the blocking levels at specified frequency offsets shall be equal to or greater than the limits defined in table 4.

Table 4: Receiver Blocking parameters			
Wanted signal mean power from companion device (dBm)	Blocking signal frequency (MHz)	Blocking signal power (dBm)	Type of blocking signal
$P_{MIN} + 6 \text{ dB}$	5 420	-42	CW
	5 925		
$P_{MIN} + 6 \text{ dB}$	5 320		CW
	6 025		
	6 125		

NOTE 1: Pmin is the minimum level of the wanted signal (in dBm) required to meet the minimum performance criteria as defined in clause 4.2.7.3 in the absence of any blocking signal.

NOTE 2: The levels specified are levels in front of the UUT antenna. In case of conducted measurements, the same levels should be used at the antenna connector irrespective of antenna gain.

3.2. Test Setup

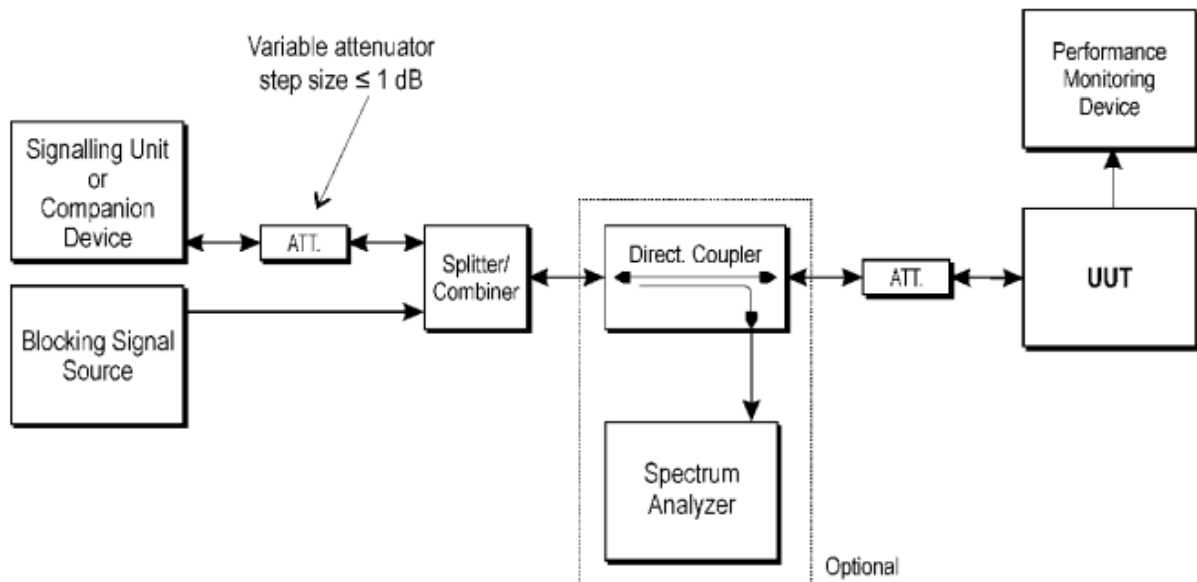
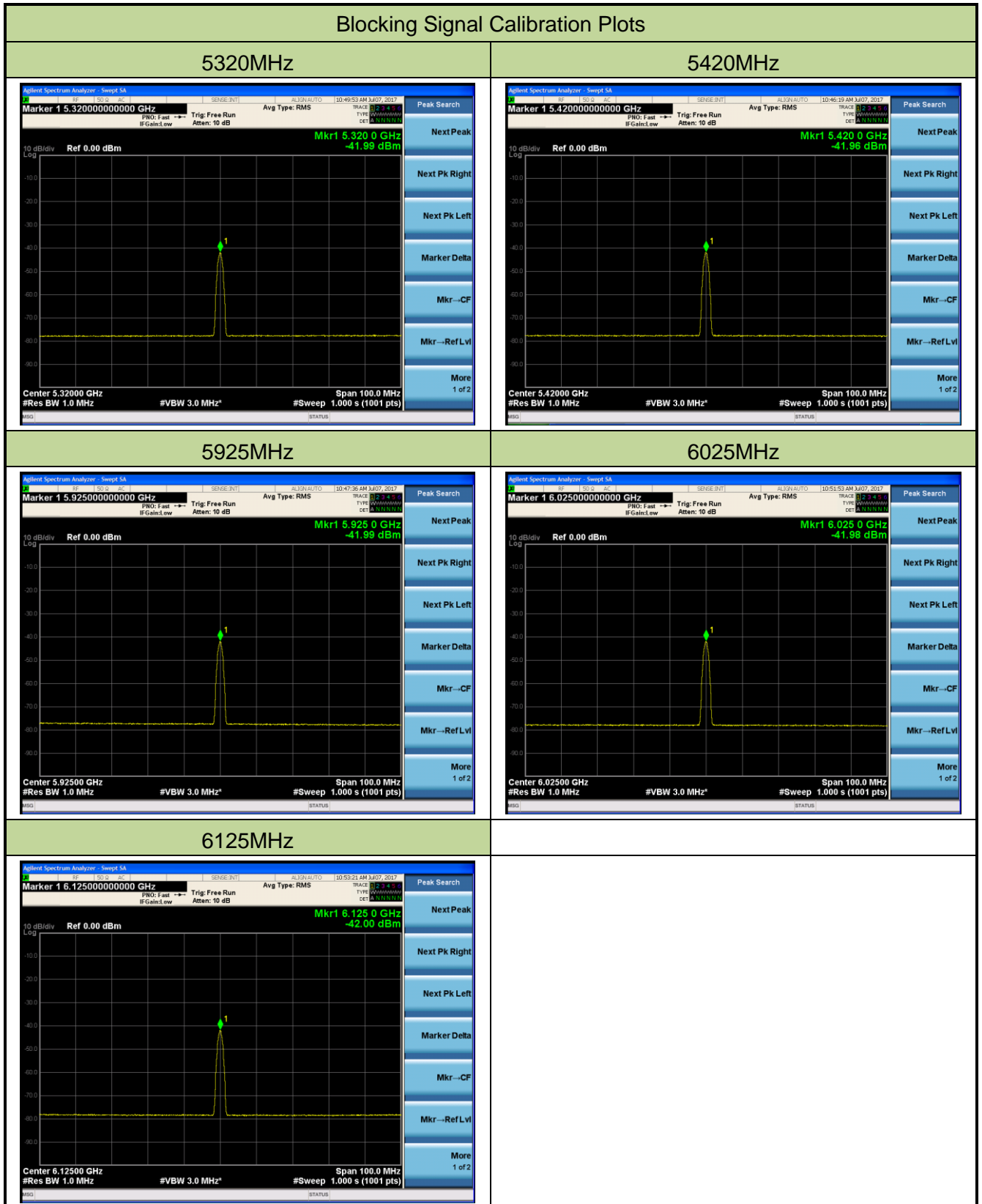

Figure 9: Test Set-up for receiver blocking

3.3. Test Procedure

Refer to ETSI EN 302 502 V2.1.1 (2017-03) Clause 5.4.7.2.1

3.4. Test Result



Test Engineer	Andy Zhu	Temperature	26°C
Test Data	2017/07/07	Relative Humidity	54%
Test Mode	802.11a	Test Site	TR4

Channel	Wanted Signal Mean Power from Companion Device (dBm)	Blocking Signal Frequency (MHz)	Blocking Signal Power (dBm)	Type of Blocking Signal	PER Test Result	Limit (PER)	Test Result
149	$P_{\text{MIN}} + 6 \text{ dB}$	5420	-42	CW	0.0	< 10%	Pass
		5925			0.0		Pass
		5320			0.0		Pass
		6025			0.1		Pass
		6125			0.0		Pass

Test Engineer	Andy Zhu	Temperature	26°C
Test Data	2017/07/07	Relative Humidity	54%
Test Mode	802.11n-HT20	Test Site	TR4

Channel	Wanted Signal Mean Power from Companion Device (dBm)	Blocking Signal Frequency (MHz)	Blocking Signal Power (dBm)	Type of Blocking Signal	PER Test Result	Limit (PER)	Test Result
149	$P_{\text{MIN}} + 6 \text{ dB}$	5420	-42	CW	0.7	< 10%	Pass
		5925			0.5		Pass
		5320			0.2		Pass
		6025			0.1		Pass
		6125			0.3		Pass

4. Measurement Uncertainty

Where relevant, the following measurement uncertainty levels have been estimated for tests performed on the apparatus:

Parameter	Uncertainty
Radio Frequency	± 10 ppm
RF output power, conducted	± 1.5 dB
Power Spectral Density, conducted	± 3 dB
Spurious Emissions, radiated	± 6 dB
Temperature	± 2 °C
Humidity	± 5 %
Time	± 10 %

5. List of Measuring Instrument

Receiver Blocking - TR3

Instrument	Manufacturer	Type No.	Serial No.	Cali. Interval	Cali. Due Date
Vector Signal Generator	Agilent	E4438C	MY49872484	1 year	2017/12/06
4 Ch. Simultaneous Sampling 14	Agilent	U2531A	TW55453505	N/A	N/A
4 Ch. Simultaneous Sampling 14	Agilent	U2531A	TW55453512	N/A	N/A
Wideband Radio Communication Tester	R&S	CMW 500	1201.0002K50	1 year	2017/11/10
Directional Coupler	Narda	4216-20	1395	1 year	2018/03/28
Power Splitter	Mini-Circuits	ZFRSC-123- S+	N/A	N/A	N/A
Temperature/Humidity Meter	Yuhuaze	HTC-2	N/A	1 year	2017/12/20

Software	Version	Function
e3	V8.3.5	EMI Test Software

_____ The End _____

6. Appendix - Original Report



MEASUREMENT REPORT

EN 302 502 V1.2.1 WLAN 802.11a/n/ac

Applicant: Compex Systems Pte Ltd
Address: No:9 Harrison Road, Harrison Industrial Building, #05-01,
Singapore 369651

Product: 802.11ac Dual Band Module
Model No.: WLE600VX, WLE600VX-I
Brand Name: COMPEX
Standards: ETSI EN 302 502 V1.2.1 (2008-07)
Result: Complies
Test Date: Mar. 16 ~ Jun. 15, 2015

Reviewed By : Robin Wu
(Robin Wu)

Approved By : Marlin Chen
(Marlin Chen)



The test results relate only to the samples tested.

The test results shown in the test report are traceable to the national/international standards through the calibration of the equipment and evaluated measurement uncertainty herein.

The test report shall not be reproduced except in full without the written approval of MRT Technology (Suzhou) Co., Ltd.

Revision History

Report No.	Version	Description	Issue Date
1612RSU02405	Rev. 01	Initial report	01-14-2017

Note: This report was based on the original report no. 1503RSU02909 and deleted one 10dBi antenna.

CONTENTS

Description	Page
1. General Information.....	5
1.1. Applicant.....	5
1.2. Manufacturer	5
1.3. Testing Facility	5
1.4. Feature of Product	6
1.5. Product Specification Subjective to this Report.....	6
1.6. Operation Frequency / Channel List	6
1.7. Description of Available Antennas.....	7
1.8. Standards Applicable for Testing.....	7
2. Test Configuration of Equipment under Test.....	8
2.1. Description of Test Mode	8
2.2. Description of Test Software	8
3. Test Summary	9
4. Carrier Frequencies.....	10
4.1. Limit.....	10
4.2. Test Setup	10
4.3. Test Procedure	10
4.4. Test Result.....	11
5. Transmitter RF Output Power, EIRP, TPC and EIRP Spectral Density.....	12
5.1. Limit.....	12
5.2. Test Setup	12
5.3. Test Procedure	12
5.4. Test Result.....	13
6. Transmitter Unwanted Emissions Outside the 5725 MHz to 5875 MHz Band	16
6.1. Limit.....	16
6.2. Test Setup	16
6.3. Test Procedure	17
6.4. Test Result.....	18
7. Transmitter Unwanted Emissions Within the 5725 MHz to 5875 MHz Band	24
7.1. Limit.....	24
7.2. Test Setup	24
7.3. Test Procedure	25
7.4. Test Result.....	26
8. Receiver Spurious Emissions.....	32

8.1. Limit.....	32
8.2. Test Setup	32
8.3. Test Procedure	32
8.4. Test Result.....	33
9. Dynamic Frequency Selection (DFS).....	39
10. Measurement Uncertainty	40
11. Test Photograph.....	41
12. List of Measuring Instrument.....	44
13. Appendix - EUT Photograph	45

1.4. Feature of Product

Product Name	802.11ac Dual Band Module
Model No.	WLE600VX, WLE600VX-I
Brand Name	COMPEX
Frequency Range	802.11a/b/g/n/ac

1.5. Product Specification Subjective to this Report

Frequency Range	802.11a /n-HT20/ac-VHT20: 5745 ~ 5825MHz
Channel Number	802.11a/n-HT20/ac-VHT20: 5
Type of Modulation	802.11a/n/ac: OFDM
Data Rate	802.11a: 6/9/12/18/24/36/48/54Mbps 802.11n: up to 300Mbps 802.11ac: up to 866.6Mbps

Note: For other features of this EUT, test report will be issued separately.

1.6. Operation Frequency / Channel List

802.11a/n-HT20/ac-VHT20

Channel	Frequency	Channel	Frequency	Channel	Frequency
149	5745 MHz	153	5765 MHz	157	5785 MHz
161	5805 MHz	165	5825 MHz	N/A	N/A

1.7. Description of Available Antennas

Antenna Type	Manufacturer	Tx Paths	Max Directional Gain (dBi)
Dipole Antenna 1#	Kunshan Wavelink Electronic Co., Ltd.	2	2.4GHz: 2.0, 5GHz: 2.0
Dipole Antenna 2#	Smart Ant Inc	2	2.4GHz: 4.5, 5GHz: 7.0
PCB Antenna 3#	TAOGLAS Inc	2	2.4GHz: 4.5, 5GHz: 6.7
PCB Antenna 4#	Compex Systems Pte Ltd	2	2.4GHz: 5.0, 5GHz: 5.0
PCB Antenna 5#	Compex Systems Pte Ltd	2	2.4GHz: 5.0, 5GHz: 5.0

Note: We selected the dipole antenna 2# and PCB antenna 3# for all radiated emission testing.

1.8. Standards Applicable for Testing

The EUT complies with the requirements of ETSI EN 302 502 V1.2.1.

2. Test Configuration of Equipment under Test

2.1. Description of Test Mode

Test Mode	Mode 1: Transmit by 802.11a
	Mode 2: Transmit by 802.11n-HT20
	Mode 3: Transmit by 802.11ac-VHT20

Test Mode	Duty Cycle
11a	96.9%
11n-HT20	94.4%
11ac-VHT20	95.0%

2.2. Description of Test Software

The test utility software used during testing was “ART2-GUI Version: 2.3”.

Final Power Parameter Value of the test software.

Test Mode	Test Frequency	Power Parameter Value		
		Ant 0	Ant 1	Ant 0 + 1
802.11a	5745	20.0	20.0	Not Support
	5785	20.0	20.0	
	5825	20.0	20.0	
802.11n-HT20	5745	20.0	20.0	16.5
	5785	20.0	20.0	16.5
	5825	20.0	20.0	16.5
802.11ac-VHT20	5745	20.0	20.0	16.5
	5785	20.0	20.0	16.0
	5825	20.0	20.0	16.5

3. Test Summary

Clause EN 302 502	Test Parameter	Result (Pass/Fail)	Remark
4.1	Frequency Error	Pass	--
4.2,4.4	Transmitter RF Output Power, EIRP, TPC and EIRP Spectral Density	Pass	--
4.3.1	Transmitter Unwanted Emissions Outside the 5725 MHz to 5875 MHz Band	Pass	--
4.3.2	Transmitter Unwanted Emissions Within the 5725 MHz to 5875 MHz Band	Pass	--
4.5	Receiver Spurious Emissions	Pass	--
4.6	Dynamic Frequency Selection (DFS)	Pass	Refer to DFS report

Note 1: For Radiated spurious emission test, every axis (X, Y, Z) was also verified. The test results shown in the following sections represent the worst case emissions.

4. Carrier Frequencies

4.1. Limit

The manufacturer shall declare the centre frequencies on which the equipment can operate. The equipment shall only operate in channels centred on any of those frequencies identified in clause 4.1.1 of standard.

The actual carrier centre frequency shall be maintained within the range $f_c \pm 20$ ppm of the nominal channel centre frequency.

4.2. Test Setup

For Conducted Measurement

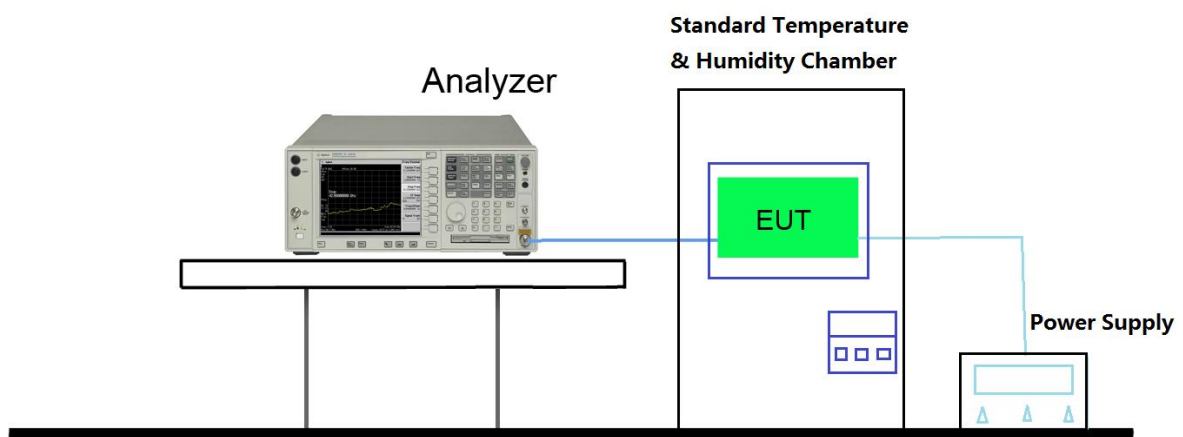

4.3. Test Procedure

Refer to ETSI EN 302 502 V1.2.1 (2008-07) Clause 5.3.2.

4.4. Test Result

Test Engineer	Milo Li	Temperature	25°C
Test Time	05-21-2015	Relative Humidity	58%

Frequency (MHz)	Measured Frequency (MHz)	Tolerance (ppm)	Limit (ppm)	Result
5745	5745.015812	2.75	≤ 20	Pass
5825	5824.956293	-7.50	≤ 20	Pass

5. Transmitter RF Output Power, EIRP, TPC and EIRP Spectral Density

5.1. Limit

The mean EIRP, RF power and EIRP spectral density when configured to operate at the highest stated power level (Pcond_1) shall not exceed the limit in following table.

Mean RF output power, EIRP and power density limits at the highest power level			
Channel Width ChS	Mean RF power into antenna(dBm)	Mean EIRP (dBm)	Mean EIRP spectral density(dBm/MHz)
10 MHz	27	33	23
20 MHz	30	36	23

The FWA device shall have the capability to reduce the operating mean EIRP level to level not exceeding 24 dBm for ChS = 20 MHz and 21 dBm for ChS = 10 MHz.

Note: The mean EIRP and the mean EIRP spectral density limits apply to a device and not to each radio of a device.

5.2. Test Setup

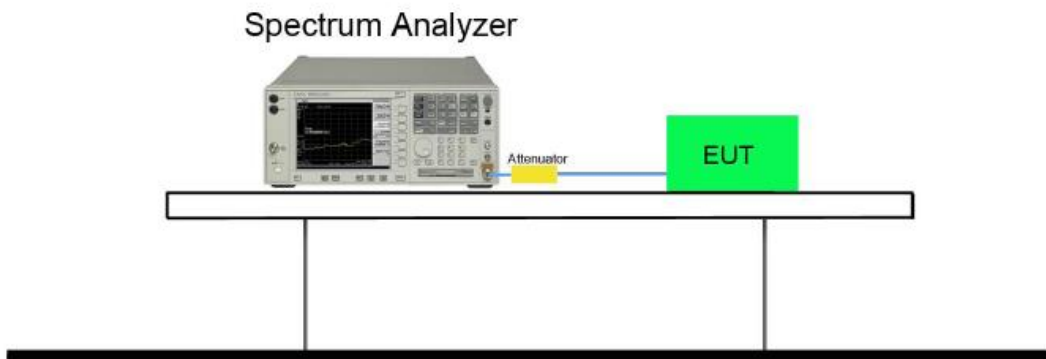

5.3. Test Procedure

Refer to ETSI EN 302 502 V1.2.1 (2008-07) Clause 5.3.3.

5.4. Test Result

Test Engineer	Milo Li	Temperature	25°C
Test Time	05-16-2015	Relative Humidity	54%

RF Output Power

1Tx

Mode	Ch. No.	Freq. (MHz)	Ant 0 Output Power (dBm)	Ant 1 Output Power (dBm)	Output Power Limit (dBm)	Gain (dBi)	Max EIRP Power (dBm)	Limit (dBm)	Result
11a	149	5745	19.57	19.66	≤30	7	26.80	≤36	Pass
11a	157	5785	19.42	19.38	≤30	7	26.56	≤36	Pass
11a	165	5825	19.53	19.34	≤30	7	26.67	≤36	Pass
n-HT20	149	5745	19.34	19.55	≤30	7	26.80	≤36	Pass
n-HT20	157	5785	19.59	19.62	≤30	7	26.87	≤36	Pass
n-HT20	165	5825	19.38	19.61	≤30	7	26.86	≤36	Pass
ac-VHT20	149	5745	19.63	18.88	≤30	7	26.85	≤36	Pass
ac-VHT20	157	5785	19.64	19.61	≤30	7	26.86	≤36	Pass
ac-VHT20	165	5825	19.42	19.59	≤30	7	26.81	≤36	Pass

Note: Max EIRP Power(dBm) = Average Power(dBm) + Antenna Gain(dBi) + 10*log(1/Duty Cycle).

2Tx

Mode	Ch. No.	Freq. (MHz)	Ant 0 Output Power (dBm)	Ant 1 Output Power (dBm)	Total Output Power (dBm)	Power Limit (dBm)	Gain (dBi)	EIRP Power (dBm)	Limit (dBm)	Result
n-HT20	149	5745	16.54	16.42	19.74	≤30	7	26.74	≤36	Pass
n-HT20	157	5785	16.51	16.26	19.65	≤30	7	26.65	≤36	Pass
n-HT20	165	5825	16.13	16.23	19.44	≤30	7	26.44	≤36	Pass
ac-VHT20	149	5745	16.61	16.36	19.71	≤30	7	26.72	≤36	Pass
ac-VHT20	157	5785	16.52	16.44	19.70	≤30	7	26.71	≤36	Pass
ac-VHT20	165	5825	16.08	16.28	19.41	≤30	7	26.41	≤36	Pass

Note: EIRP Power(dBm) = 10*log{10^(Ant 0 Output Power /10)+10^(Ant 1 Output Power /10)} + Antenna Gain(dBi) + 10*log(1/Duty Cycle).

Transmit Power Control (TPC)

Mode	Ch. No.	Freq. (MHz)	Ant 0 Output Power (dBm)	Ant 1 Output Power (dBm)	Gain (dBi)	Total of TPC (dBm)	EIRP of TPC (dBm)	Limit (dBm)	Result
n-HT20	149	5745	7.89	7.97	7	11.19	18.19	≤24	Pass
n-HT20	157	5785	7.91	7.80	7	11.12	18.12	≤24	Pass
n-HT20	165	5825	7.42	7.98	7	10.97	17.97	≤24	Pass
ac-VHT20	149	5745	7.85	7.87	7	11.09	18.09	≤24	Pass
ac-VHT20	157	5785	7.96	7.67	7	11.05	18.05	≤24	Pass
ac-VHT20	165	5825	7.38	7.71	7	10.78	17.78	≤24	Pass

Note: EIRP of TPC (dBm) = $10 \cdot \log\{10^{(\text{Ant 0 TPC Power} / 10)} + 10^{(\text{Ant 1 TPC Power} / 10)}\} + \text{Antenna Gain(dBi)} + 10 \cdot \log(1/\text{Duty Cycle})$

Power Density
1Tx

Mode	Channel	Freq. (MHz)	Spectral Power Density (dBm/MHz)		Gain (dBi)	EIRP Spectral Power Density (dBm/MHz)	Limit (dBm)	Result
			Ant 0	Ant 1				
11a	149	5745	6.22	6.45	7	13.59	≤23	Pass
11a	157	5785	6.61	6.68	7	13.82	≤23	Pass
11a	165	5825	6.56	6.94	7	14.08	≤23	Pass
n-HT20	149	5745	6.28	6.25	7	13.53	≤23	Pass
n-HT20	157	5785	6.52	6.74	7	13.99	≤23	Pass
n-HT20	165	5825	6.05	6.88	7	14.13	≤23	Pass
ac-VHT20	149	5745	6.50	6.45	7	13.72	≤23	Pass
ac-VHT20	157	5785	6.73	6.42	7	13.95	≤23	Pass
ac-VHT20	165	5825	7.02	6.63	7	14.24	≤23	Pass

Note: EIRP Spectral Power Density (dBm/MHz) = Spectral Power Density (dBm/MHz) + Antenna Gain(dBi) + 10*log(1/Duty Cycle).

2Tx

Mode	Channel	Freq. (MHz)	Spectral Power Density (dBm/MHz)		Total Spectral Power Density (dBm/MHz)	Gain (dBi)	EIRP Spectral Power Density (dBm/MHz)	Limit (dBm)	Result
			Ant 0	Ant 1					
n-HT20	149	5745	6.78	6.72	10.01	7	17.01	≤23	Pass
n-HT20	157	5785	6.81	6.65	9.99	7	16.99	≤23	Pass
n-HT20	165	5825	6.96	6.88	10.18	7	17.18	≤23	Pass
ac-VHT20	149	5745	6.34	6.63	9.72	7	16.72	≤23	Pass
ac-VHT20	157	5785	6.24	6.69	9.70	7	16.70	≤23	Pass
ac-VHT20	165	5825	6.41	7.02	9.96	7	16.96	≤23	Pass

Note: EIRP Spectral Power Density (dBm/MHz) = $10 \cdot \log\{10^{(\text{Ant 0 PSD}/10)} + 10^{(\text{Ant 1 PSD}/10)}\}$ (dBm/MHz) + Antenna Gain(dBi) + 10*log(1/Duty Cycle).

6. Transmitter Unwanted Emissions Outside the 5725 MHz to 5875 MHz Band

6.1. Limit

Frequency Range (MHz)	Limit (dBm)	Bandwidth (kHz) (see note)
30 to 1000	-36	100
1000 to 5725	-30	1000
5875 to 26500	-30	1000

Note: At frequencies just below 5725 MHz or just above 5875 MHz, account shall be taken of the spacing between the emission centre frequency and the measurement centre frequency to evaluate the appropriate reference bandwidth given in annex 2 of CEPT/ERC Recommendation 74-01 [10].

6.2. Test Setup

Below 1GHz Test Setup:

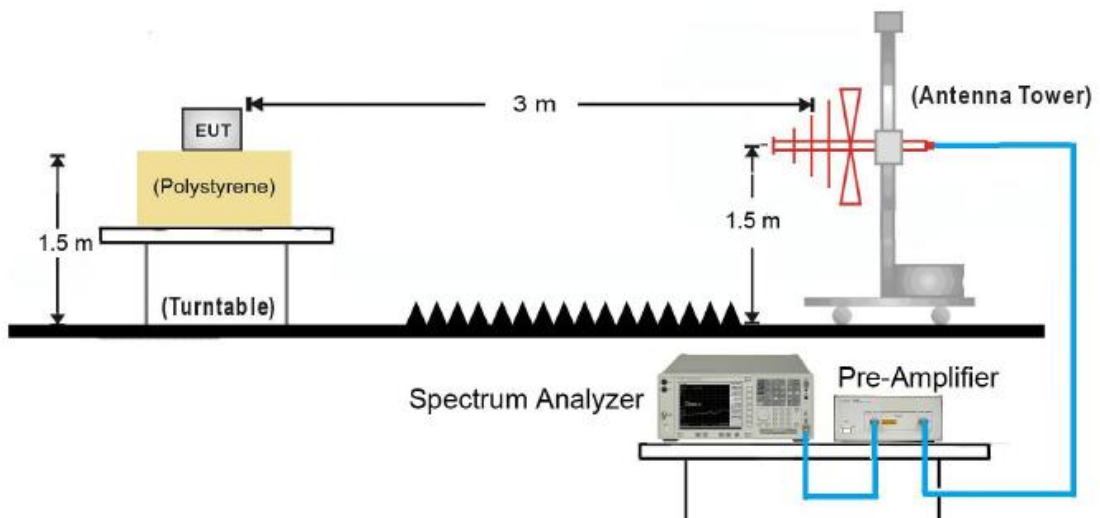

Above 1GHz Test Setup:

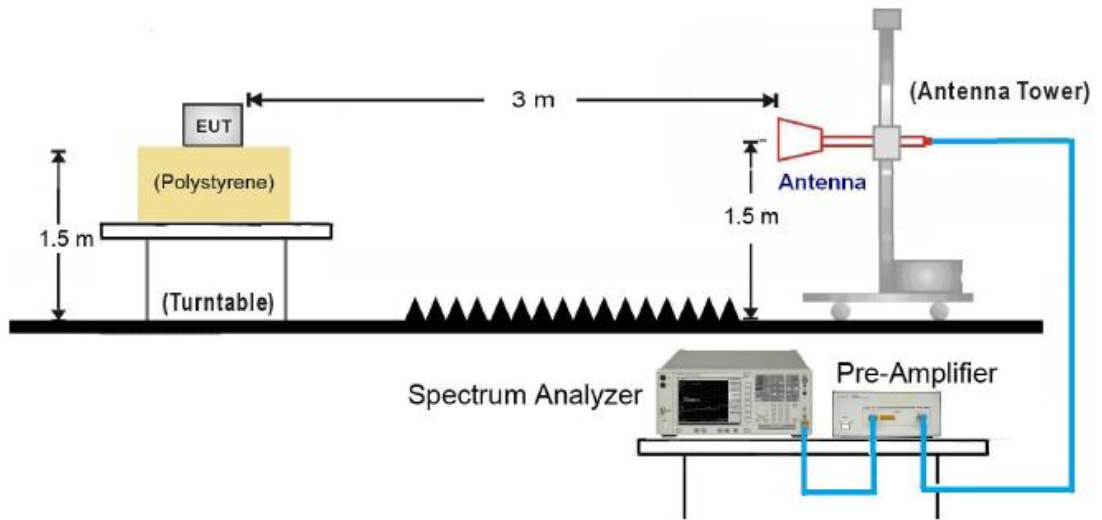

6.3. Test Procedure

Refer to ETSI EN 302 502 V1.2.1 (2008-07) Clause 5.3.4.1.

6.4. Test Result

Dipole Antenna

Test Engineer	Milo Li	Temperature	26°C
Test Time	05-19-2015	Relative Humidity	54%
Test Mode	802.11a – 1Tx	Test Site	AC1

Channel	Frequency (MHz)	Measure Level (dBm)	Limit (dBm)	Margin (dB)	Detector	Polarization
149	675.7	-64.4	-36.0	-28.4	Peak	Horizontal
	513.5	-68.0	-36.0	-32.0	Peak	Vertical
	856.4	-67.6	-36.0	-31.6	Peak	Horizontal
	612.5	-66.5	-36.0	-30.5	Peak	Vertical
	11491.1	-41.3	-30.0	-11.3	Peak	Horizontal
	11491.1	-43.2	-30.0	-13.2	Peak	Vertical
	17236.1	-34.5	-30.0	-4.5	Peak	Horizontal
	17236.1	-36.9	-30.0	-6.9	Peak	Vertical
165	606.7	-69.0	-36.0	-33.0	Peak	Horizontal
	320.4	-71.0	-36.0	-35.0	Peak	Vertical
	662.4	-68.3	-36.0	-32.3	Peak	Horizontal
	561.7	-65.8	-36.0	-29.8	Peak	Vertical
	11651.1	-36.2	-30.0	-6.2	Peak	Horizontal
	11651.1	-37.7	-30.0	-7.7	Peak	Vertical
	17476.1	-34.8	-30.0	-4.8	Peak	Horizontal
	17476.1	-35.3	-30.0	-5.3	Peak	Vertical

Test Engineer	Milo Li	Temperature	26°C
Test Time	05-19-2015	Relative Humidity	54%
Test Mode	802.11n-HT20 – 2Tx	Test Site	AC1

Channel	Frequency (MHz)	Measure Level (dBm)	Limit (dBm)	Margin (dB)	Detector	Polarization
149	383.9	-65.3	-36.0	-29.3	Peak	Horizontal
	630.1	-62.1	-36.0	-26.1	Peak	Vertical
	724.6	-66.4	-36.0	-30.4	Peak	Horizontal
	826.1	-67.6	-36.0	-31.6	Peak	Vertical
	11491.1	-41.5	-30.0	-11.5	Peak	Horizontal
	11491.1	-43.6	-30.0	-13.6	Peak	Vertical
	17236.1	-33.8	-30.0	-3.8	Peak	Horizontal
	17236.1	-37.4	-30.0	-7.4	Peak	Vertical
165	504.7	-64.6	-36.0	-28.6	Peak	Horizontal
	626.6	-62.3	-36.0	-26.3	Peak	Vertical
	601.4	-66.0	-36.0	-30.0	Peak	Horizontal
	823.1	-69.4	-36.0	-33.4	Peak	Vertical
	11651.1	-35.1	-30.0	-5.1	Peak	Horizontal
	11651.1	-37.6	-30.0	-7.6	Peak	Vertical
	17476.1	-34.7	-30.0	-4.7	Peak	Horizontal
	17476.1	-36.5	-30.0	-6.5	Peak	Vertical

Test Engineer	Milo Li	Temperature	26°C
Test Time	05-19-2015	Relative Humidity	54%
Test Mode	802.11ac-VHT20 – 2Tx	Test Site	AC1

Channel	Frequency (MHz)	Measure Level (dBm)	Limit (dBm)	Margin (dB)	Detector	Polarization
149	124.5	-61.8	-36.0	-25.8	Peak	Horizontal
	-73.5	-61.9	-36.0	-25.9	Peak	Vertical
	308.8	-62.1	-36.0	-26.1	Peak	Horizontal
	375.0	-60.8	-36.0	-24.8	Peak	Vertical
	11491.1	-41.4	-30.0	-11.4	Peak	Horizontal
	11491.1	-42.9	-30.0	-12.9	Peak	Vertical
	17236.1	-35.0	-30.0	-5.0	Peak	Horizontal
	17236.1	-37.3	-30.0	-7.3	Peak	Vertical
165	180.9	-65.2	-36.0	-29.2	Peak	Horizontal
	151.0	-61.5	-36.0	-25.5	Peak	Vertical
	208.9	-51.6	-36.0	-15.6	Peak	Horizontal
	246.4	-51.5	-36.0	-15.5	Peak	Vertical
	11651.1	-39.6	-30.0	-9.6	Peak	Horizontal
	11651.1	-36.9	-30.0	-6.9	Peak	Vertical
	17476.1	-34.6	-30.0	-4.6	Peak	Horizontal
	17476.1	-35.0	-30.0	-5.0	Peak	Vertical

PCB Antenna

Test Engineer	Milo Li	Temperature	26°C
Test Time	05-20-2015	Relative Humidity	54%
Test Mode	802.11a – 1Tx	Test Site	AC1

Channel	Frequency (MHz)	Measure Level (dBm)	Limit (dBm)	Margin (dB)	Detector	Polarization
149	675.5	-64.5	-36.0	-28.5	Peak	Horizontal
	513.5	-68.1	-36.0	-32.1	Peak	Vertical
	856.2	-67.7	-36.0	-31.7	Peak	Horizontal
	612.5	-66.6	-36.0	-30.6	Peak	Vertical
	11490.0	-41.5	-30.0	-11.5	Peak	Horizontal
	11490.0	-43.4	-30.0	-13.4	Peak	Vertical
	17236.0	-34.6	-30.0	-4.6	Peak	Horizontal
	17236.0	-37.0	-30.0	-7.0	Peak	Vertical
165	606.7	-69.1	-36.0	-33.1	Peak	Horizontal
	320.4	-71.1	-36.0	-35.1	Peak	Vertical
	662.2	-68.5	-36.0	-32.5	Peak	Horizontal
	561.7	-65.9	-36.0	-29.9	Peak	Vertical
	11651.0	-36.3	-30.0	-6.3	Peak	Horizontal
	11651.0	-37.9	-30.0	-7.9	Peak	Vertical
	17476.0	-35.0	-30.0	-5.0	Peak	Horizontal
	17476.0	-35.4	-30.0	-5.4	Peak	Vertical

Test Engineer	Milo Li	Temperature	26°C
Test Time	05-19-2015	Relative Humidity	54%
Test Mode	802.11n-HT20 – 2Tx	Test Site	AC1

Channel	Frequency (MHz)	Measure Level (dBm)	Limit (dBm)	Margin (dB)	Detector	Polarization
149	383.5	-65.7	-36.0	-29.7	Peak	Horizontal
	630.1	-62.3	-36.0	-26.3	Peak	Vertical
	724.6	-66.5	-36.0	-30.5	Peak	Horizontal
	826.1	-67.8	-36.0	-31.8	Peak	Vertical
	11491.0	-41.8	-30.0	-11.8	Peak	Horizontal
	11491.0	-44.1	-30.0	-14.1	Peak	Vertical
	17236.0	-34.1	-30.0	-4.1	Peak	Horizontal
	17236.0	-38.0	-30.0	-8.0	Peak	Vertical
165	504.7	-65.4	-36.0	-29.4	Peak	Horizontal
	626.6	-62.7	-36.0	-26.7	Peak	Vertical
	601.4	-66.2	-36.0	-30.2	Peak	Horizontal
	823.1	-69.5	-36.0	-33.5	Peak	Vertical
	11651.0	-35.3	-30.0	-5.3	Peak	Horizontal
	11651.0	-37.9	-30.0	-7.9	Peak	Vertical
	17476.0	-35.2	-30.0	-5.2	Peak	Horizontal
	17476.0	-36.8	-30.0	-6.8	Peak	Vertical

Test Engineer	Milo Li	Temperature	26°C
Test Time	05-19-2015	Relative Humidity	54%
Test Mode	802.11ac-VHT20 – 2Tx	Test Site	AC1

Channel	Frequency (MHz)	Measure Level (dBm)	Limit (dBm)	Margin (dB)	Detector	Polarization
149	124.5	-62.0	-36.0	-26.0	Peak	Horizontal
	-73.5	-62.1	-36.0	-26.1	Peak	Vertical
	308.8	-62.3	-36.0	-26.3	Peak	Horizontal
	375.0	-61.0	-36.0	-25.0	Peak	Vertical
	11491.1	-41.7	-30.0	-11.7	Peak	Horizontal
	11491.1	-43.4	-30.0	-13.4	Peak	Vertical
	17236.1	-35.3	-30.0	-5.3	Peak	Horizontal
	17236.1	-37.9	-30.0	-7.9	Peak	Vertical
165	180.9	-66.0	-36.0	-30.0	Peak	Horizontal
	151.0	-61.7	-36.0	-25.7	Peak	Vertical
	208.9	-51.8	-36.0	-15.8	Peak	Horizontal
	246.4	-51.6	-36.0	-15.6	Peak	Vertical
	11651.1	-39.8	-30.0	-9.8	Peak	Horizontal
	11651.1	-37.2	-30.0	-7.2	Peak	Vertical
	17476.1	-35.1	-30.0	-5.1	Peak	Horizontal
	17476.1	-35.4	-30.0	-5.4	Peak	Vertical

7. Transmitter Unwanted Emissions Within the 5725 MHz to 5875 MHz Band

7.1. Limit

The average level of the transmitted spectrum based on the declared ChS shall not exceed the limits given in figure 1 when operating under highest output power conditions.

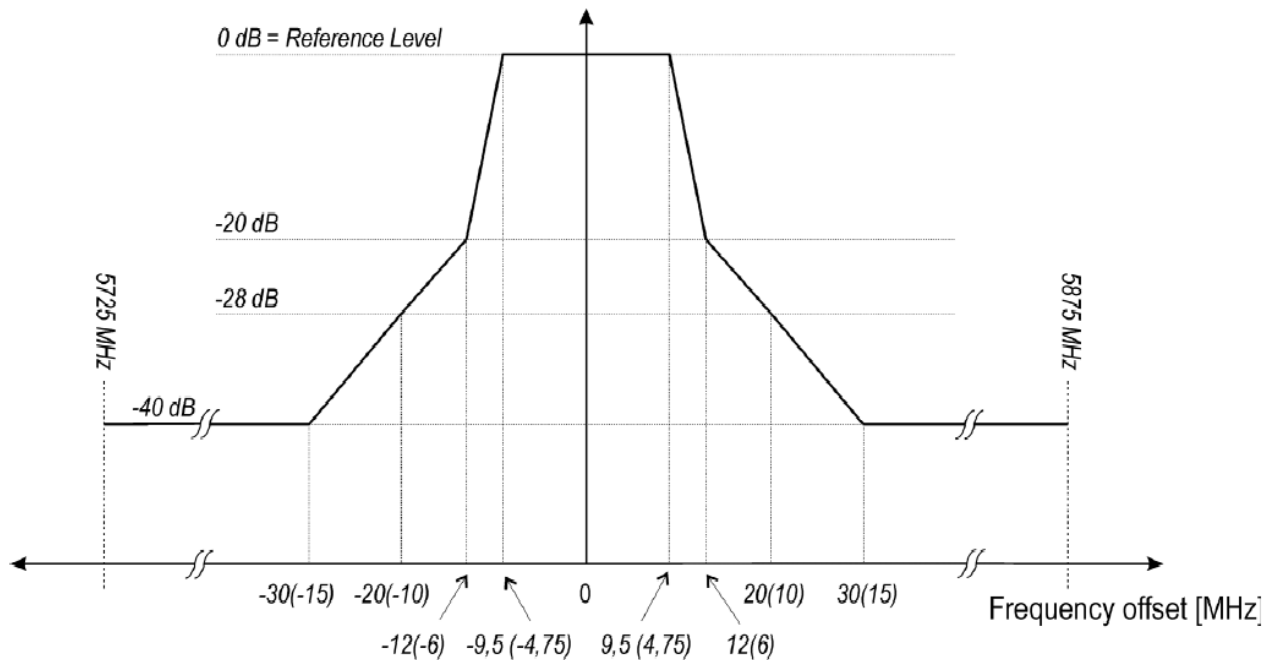

NOTE 1: 0 dB Reference Level is the spectral density relative to the maximum spectral power density of the transmitted signal.

NOTE 2: On the Frequency Offset axis, the figures apply to ChS = 20 MHz whereas the figures in parentheses apply to ChS = 10 MHz.

NOTE 3: Emissions that fall outside the lower and upper band frequency limits of 5 725 MHz and 5 875 MHz respectively shall instead meet the unwanted emission limits of clause 4.3.1.

7.2. Test Setup

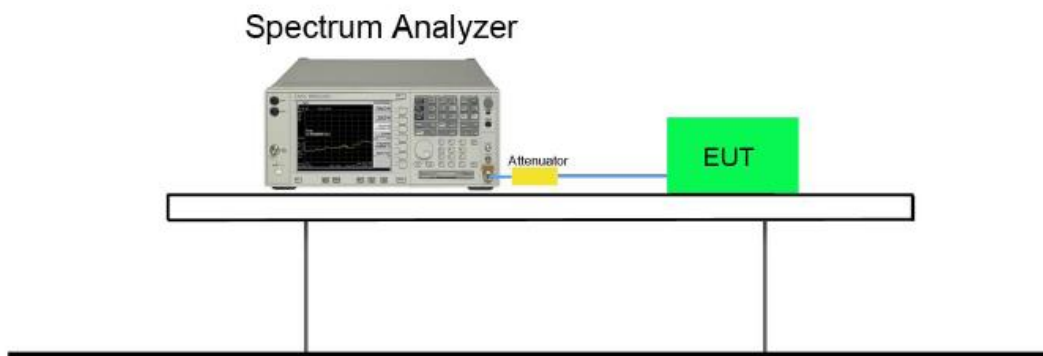

7.3. Test Procedure

Refer to ETSI EN 302 502 V1.2.1 (2008-07) Clause 5.3.4.2.

7.4. Test Result

Test Engineer	Milo Li	Temperature	26°C
Test Time	06-13-2015	Relative Humidity	54%

Test Mode	Channel No.	Frequency (MHz)	Result
1Tx			
802.11a	149	5745	Pass
802.11a	165	5825	Pass
802.11n-HT20	149	5745	Pass
802.11n-HT20	165	5825	Pass
802.11ac-VHT20	149	5745	Pass
802.11ac-VHT20	165	5825	Pass
2Tx			
802.11n-HT20	149	5745	Pass
802.11n-HT20	165	5825	Pass
802.11ac-VHT20	149	5745	Pass
802.11ac-VHT20	165	5825	Pass

Transmitter Unwanted Emissions Within the 5GHz RLAN Bands

802.11a – 1Tx

Channel 149 (5745MHz)

The Reference Level

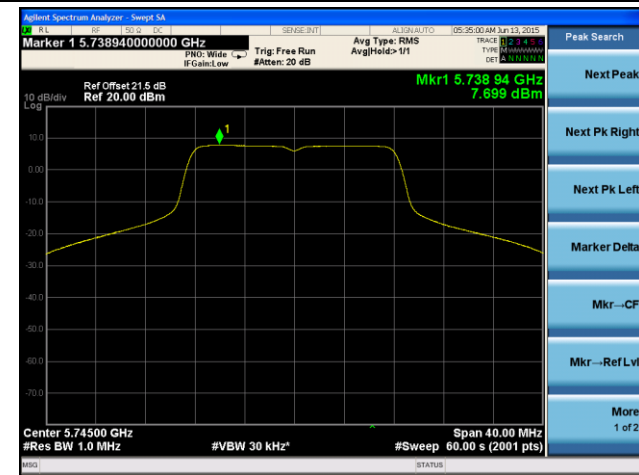

The Mask Data



Channel 165 (5825MHz)

The Reference Level

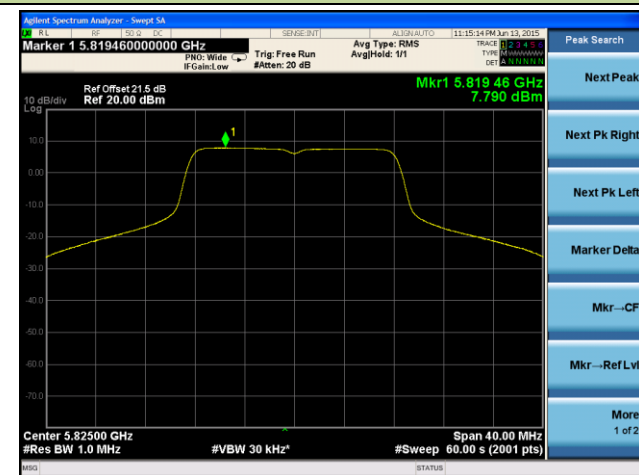

The Mask Data

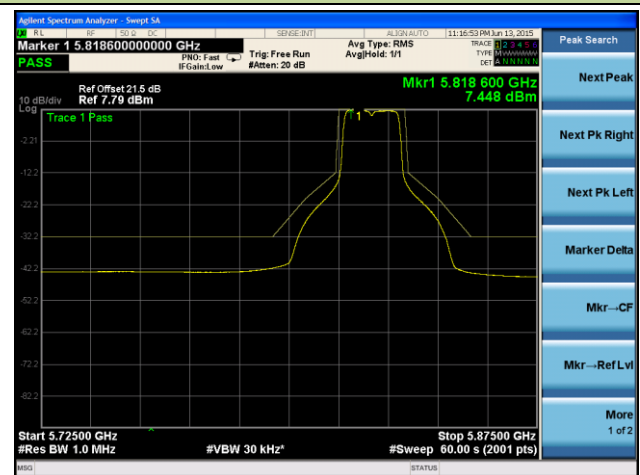

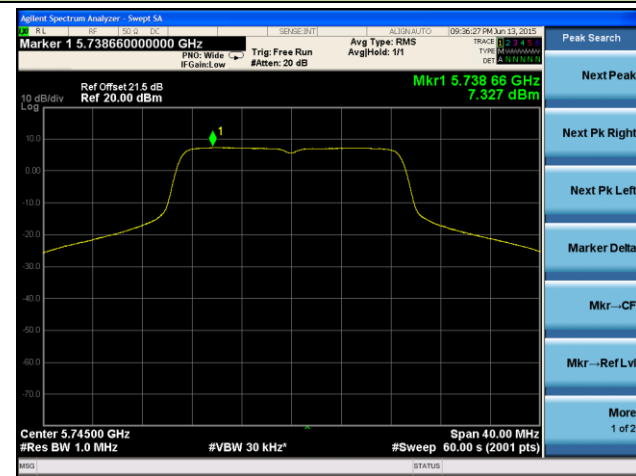
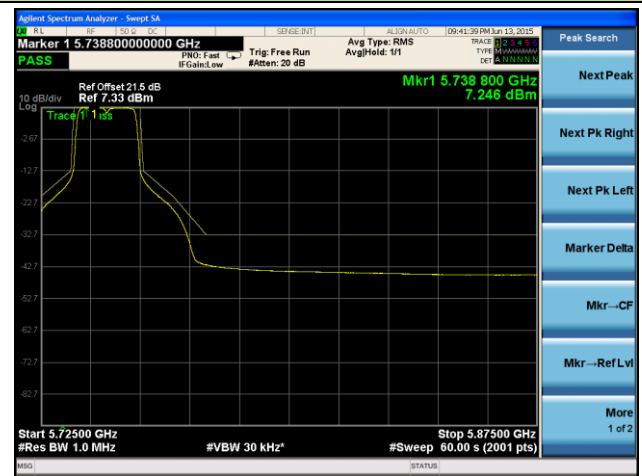
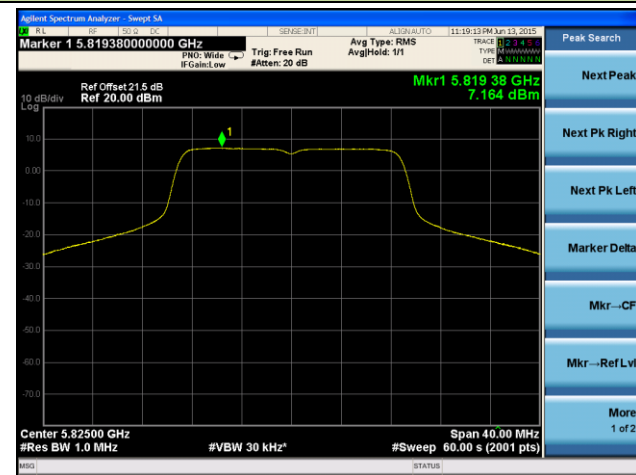
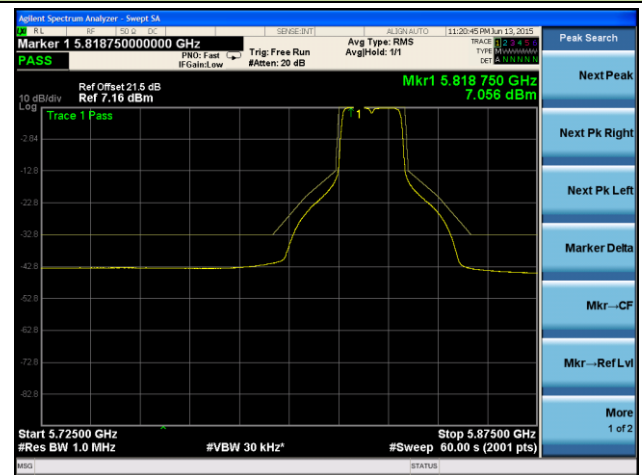
802.11n-HT20 – 1Tx
Channel 149 (5745MHz)
The Reference Level

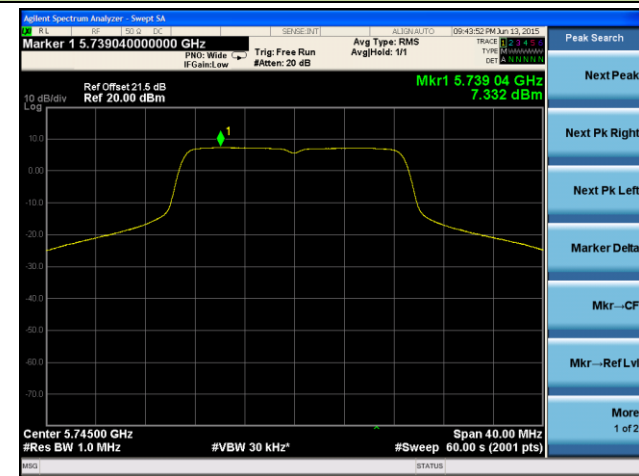
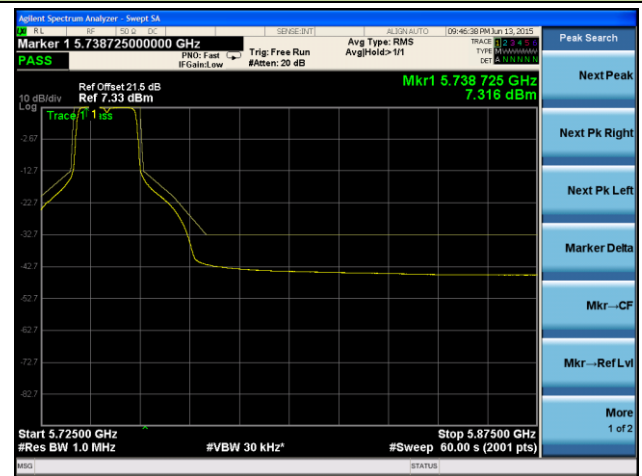
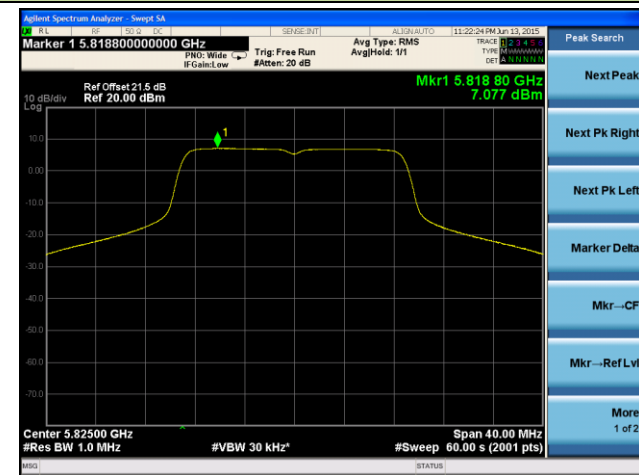
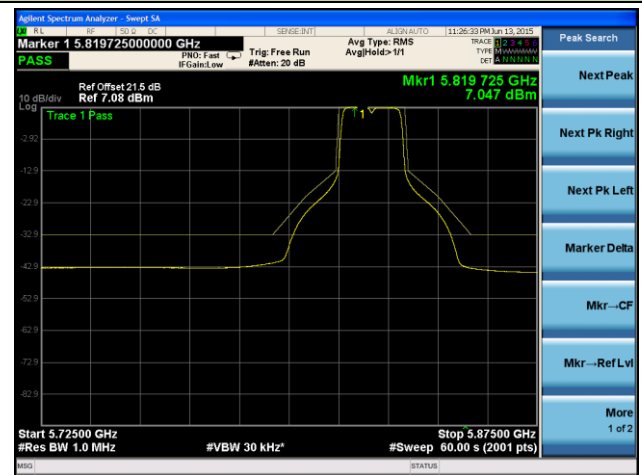
The Mask Data

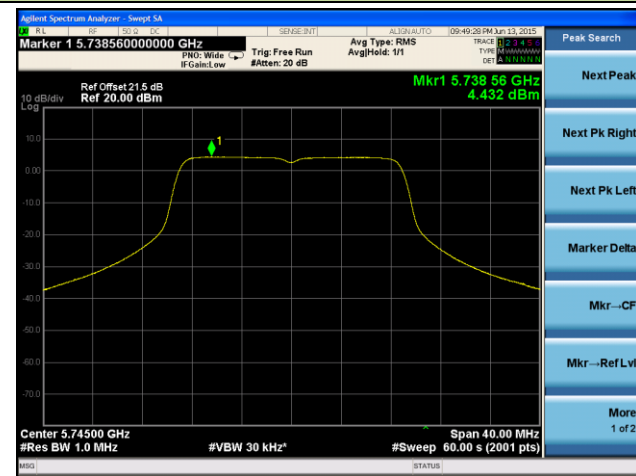
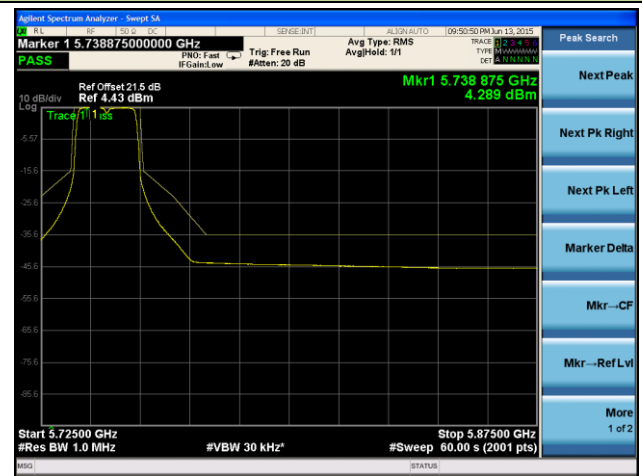
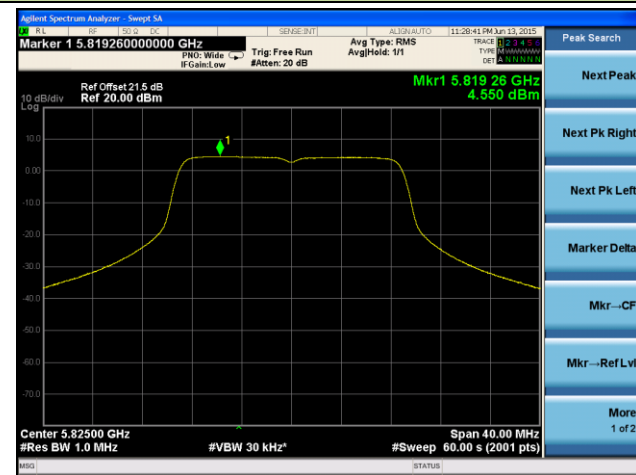
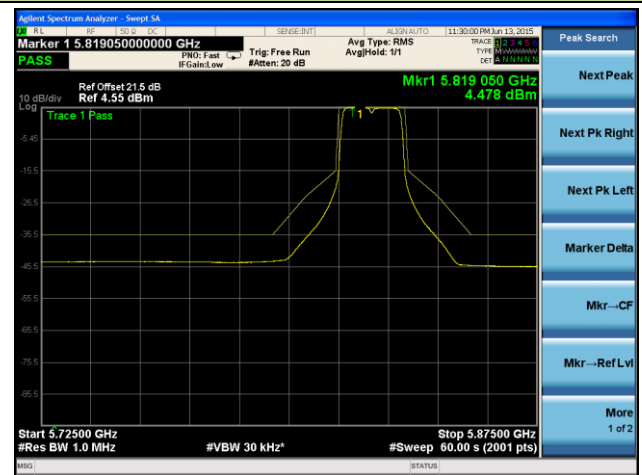
Channel 165 (5825MHz)
The Reference Level

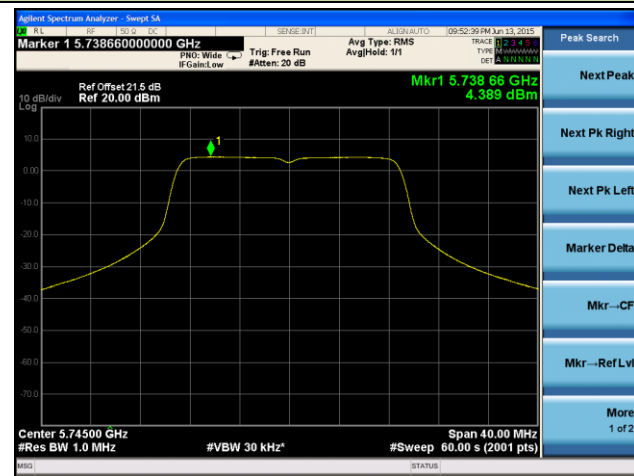
The Mask Data

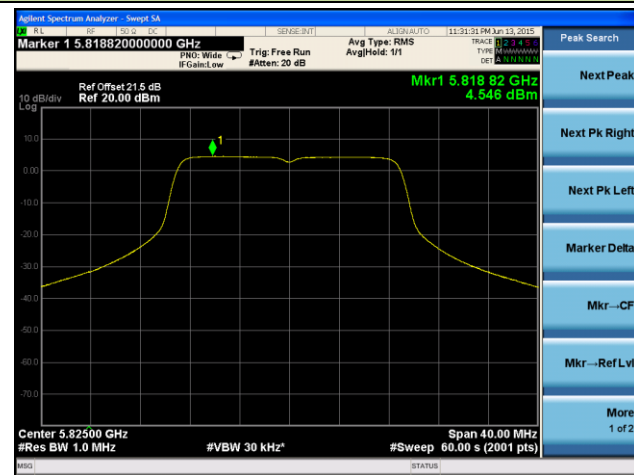
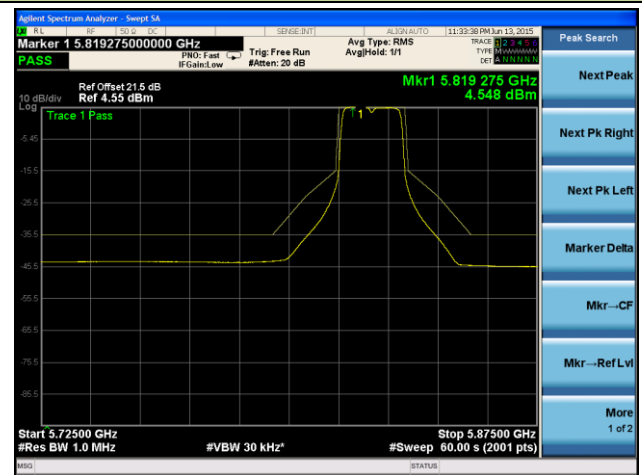
802.11ac-VHT20 – 1Tx
Channel 149 (5745MHz)
The Reference Level

The Mask Data

Channel 165 (5825MHz)
The Reference Level

The Mask Data

802.11n-HT20 – 2Tx
Channel 149 (5745MHz)
The Reference Level

The Mask Data

Channel 165 (5825MHz)
The Reference Level

The Mask Data

802.11ac-VHT20 – 2Tx
Channel 149 (5745MHz)
The Reference Level

The Mask Data

Channel 165 (5825MHz)
The Reference Level

The Mask Data

8. Receiver Spurious Emissions

8.1. Limit

Frequency Range	Maximum Power, ERP	Measurement Bandwidth
30 MHz to 1GHz	-57 dBm	100 kHz
1 GHz to 26.5 GHz	-47 dBm	1 MHz

8.2. Test Setup

Below 1GHz Test Setup:

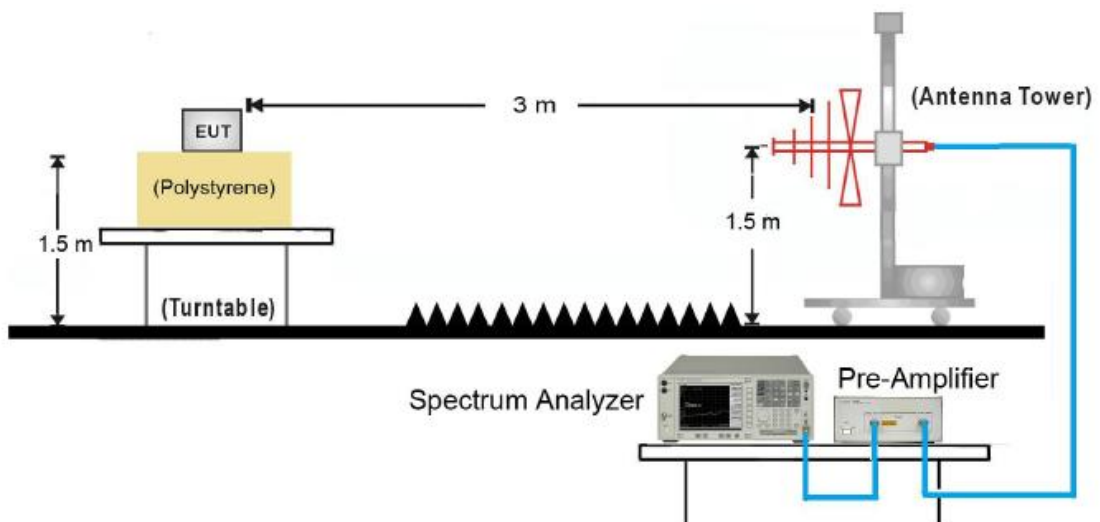

Above 1GHz Test Setup:

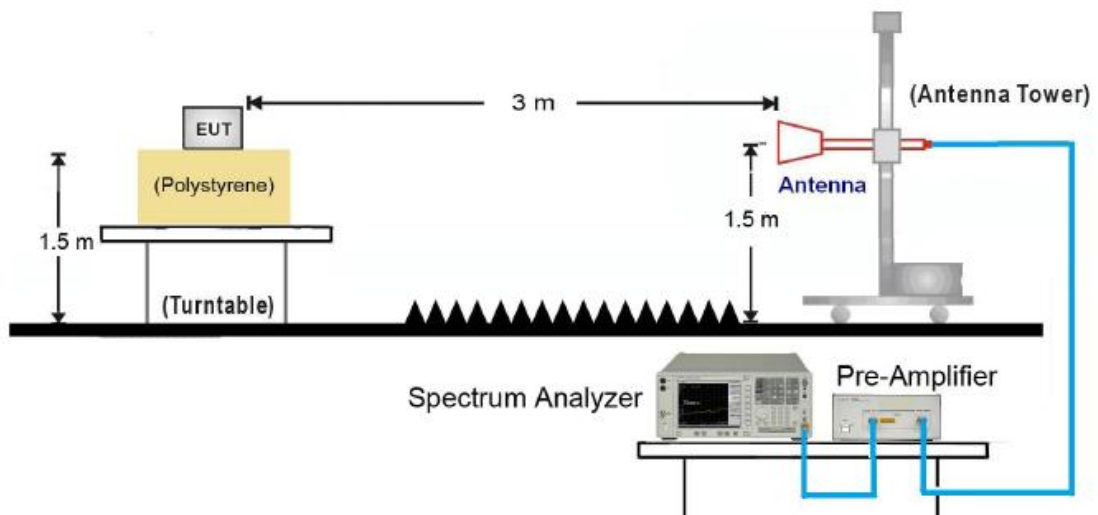

8.3. Test Procedure

Refer to ETSI EN 302 502 V1.2.1 (2008-07) Clause 5.3.5.

8.4. Test Result

Dipole Antenna

Test Engineer	Milo Li	Temperature	26°C
Test Time	05-19-2015	Relative Humidity	54%
Test Mode	802.11a	Test Site	AC1

Channel	Frequency (MHz)	Measure Level (dBm)	Limit (dBm)	Margin (dB)	Detector	Polarization
149	95.5	-73.2	-57.0	-16.2	Peak	Horizontal
	109.3	-66.0	-57.0	-9.0	Peak	Vertical
	380.0	-69.4	-57.0	-12.4	Peak	Horizontal
	192.5	-62.4	-57.0	-5.4	Peak	Vertical
	2175.5	-54.5	-47.0	-7.5	Peak	Horizontal
	1401.9	-53.1	-47.0	-6.1	Peak	Vertical
	2834.4	-53.6	-47.0	-6.6	Peak	Horizontal
	2058.8	-53.6	-47.0	-6.6	Peak	Vertical
165	455.9	-68.3	-57.0	-11.3	Peak	Horizontal
	324.5	-59.1	-57.0	-2.1	Peak	Vertical
	713.7	-71.2	-57.0	-14.2	Peak	Horizontal
	592.6	-65.6	-57.0	-8.6	Peak	Vertical
	2189.0	-54.8	-47.0	-7.8	Peak	Horizontal
	2284.0	-52.0	-47.0	-5.0	Peak	Vertical
	3827.7	-52.7	-47.0	-5.7	Peak	Horizontal
	2660.1	-52.3	-47.0	-5.3	Peak	Vertical

Note 1: Margin (dB) = Measure Level (dBm) – Limit (dBm).

Note 2: Other frequency was base noise below limit line within 18-26.5GHz, there is not show in the report.

Test Engineer	Milo Li	Temperature	26°C
Test Time	05-19-2015	Relative Humidity	54%
Test Mode	802.11n-HT20	Test Site	AC1

Channel	Frequency (MHz)	Measure Level (dBm)	Limit (dBm)	Margin (dB)	Detector	Polarization
149	150.8	-71.0	-57.0	-14.0	Peak	Horizontal
	313.9	-63.5	-57.0	-6.5	Peak	Vertical
	312.5	-69.1	-57.0	-12.1	Peak	Horizontal
	587.0	-62.0	-57.0	-5.0	Peak	Vertical
	2127.2	-55.5	-47.0	-8.5	Peak	Horizontal
	1501.9	-51.7	-47.0	-4.7	Peak	Vertical
	2970.6	-54.0	-47.0	-7.0	Peak	Horizontal
	3071.8	-53.0	-47.0	-6.0	Peak	Vertical
165	359.6	-68.6	-57.0	-11.6	Peak	Horizontal
	242.2	-64.6	-57.0	-7.6	Peak	Vertical
	711.8	-68.2	-57.0	-11.2	Peak	Horizontal
	584.4	-63.5	-57.0	-6.5	Peak	Vertical
	1223.9	-50.3	-47.0	-3.3	Peak	Horizontal
	1482.4	-53.8	-47.0	-6.8	Peak	Vertical
	2128.4	-53.9	-47.0	-6.9	Peak	Horizontal
	1967.9	-53.1	-47.0	-6.1	Peak	Vertical

Note 1: Margin (dB) = Measure Level (dBm) – Limit (dBm).

Note 2: Other frequency was base noise below limit line within 18-26.5GHz, there is not show in the report.

Test Engineer	Milo Li	Temperature	26°C
Test Time	05-19-2015	Relative Humidity	54%
Test Mode	802.11ac-VHT20	Test Site	AC1

Channel	Frequency (MHz)	Measure Level (dBm)	Limit (dBm)	Margin (dB)	Detector	Polarization
149	158.7	-69.1	-57.0	-12.1	Peak	Horizontal
	196.4	-65.9	-57.0	-8.9	Peak	Vertical
	361.2	-67.9	-57.0	-10.9	Peak	Horizontal
	592.8	-63.0	-57.0	-6.0	Peak	Vertical
	2014.0	-56.7	-47.0	-9.7	Peak	Horizontal
	1423.4	-54.5	-47.0	-7.5	Peak	Vertical
	3082.7	-53.9	-47.0	-6.9	Peak	Horizontal
	3044.8	-51.6	-47.0	-4.6	Peak	Vertical
165	473.0	-70.7	-57.0	-13.7	Peak	Horizontal
	377.2	-64.4	-57.0	-7.4	Peak	Vertical
	696.8	-73.0	-57.0	-16.0	Peak	Horizontal
	493.6	-65.4	-57.0	-8.4	Peak	Vertical
	1089.5	-55.2	-47.0	-8.2	Peak	Horizontal
	1474.2	-50.5	-47.0	-3.5	Peak	Vertical
	2078.6	-53.8	-47.0	-6.8	Peak	Horizontal
	1992.3	-55.2	-47.0	-8.2	Peak	Vertical

Note 1: Margin (dB) = Measure Level (dBm) – Limit (dBm).

Note 2: Other frequency was base noise below limit line within 18-26.5GHz, there is not show in the report.

PCB Antenna

Test Engineer	Milo Li	Temperature	26°C
Test Time	05-20-2015	Relative Humidity	54%
Test Mode	802.11a	Test Site	AC1

Channel	Frequency (MHz)	Measure Level (dBm)	Limit (dBm)	Margin (dB)	Detector	Polarization
149	95.5	-73.9	-57.0	-16.9	Peak	Horizontal
	109.3	-66.4	-57.0	-9.4	Peak	Vertical
	380.0	-69.6	-57.0	-12.6	Peak	Horizontal
	192.5	-63.4	-57.0	-6.4	Peak	Vertical
	2175.5	-54.9	-47.0	-7.9	Peak	Horizontal
	1401.9	-53.6	-47.0	-6.6	Peak	Vertical
	2834.4	-53.9	-47.0	-6.9	Peak	Horizontal
	2058.8	-54.2	-47.0	-7.2	Peak	Vertical
165	455.9	-69.1	-57.0	-12.1	Peak	Horizontal
	324.5	-59.3	-57.0	-2.3	Peak	Vertical
	713.7	-71.6	-57.0	-14.6	Peak	Horizontal
	592.6	-65.7	-57.0	-8.7	Peak	Vertical
	2189.0	-55.0	-47.0	-8.0	Peak	Horizontal
	2284.0	-52.3	-47.0	-5.3	Peak	Vertical
	3827.7	-53.2	-47.0	-6.2	Peak	Horizontal
	2660.1	-52.7	-47.0	-5.7	Peak	Vertical

Note 1: Margin (dB) = Measure Level (dBm) – Limit (dBm).

Note 2: Other frequency was base noise below limit line within 18-26.5GHz, there is not show in the report.

Test Engineer	Milo Li	Temperature	26°C
Test Time	05-20-2015	Relative Humidity	54%
Test Mode	802.11n-HT20	Test Site	AC1

Channel	Frequency (MHz)	Measure Level (dBm)	Limit (dBm)	Margin (dB)	Detector	Polarization
149	150.8	-71.7	-57.0	-14.7	Peak	Horizontal
	313.9	-63.9	-57.0	-6.9	Peak	Vertical
	312.5	-69.3	-57.0	-12.3	Peak	Horizontal
	587.0	-63.5	-57.0	-6.5	Peak	Vertical
	2127.2	-56.4	-47.0	-9.4	Peak	Horizontal
	1501.9	-52.2	-47.0	-5.2	Peak	Vertical
	2970.6	-54.4	-47.0	-7.4	Peak	Horizontal
	3071.8	-53.1	-47.0	-6.1	Peak	Vertical
165	359.6	-69.4	-57.0	-12.4	Peak	Horizontal
	242.2	-64.8	-57.0	-7.8	Peak	Vertical
	711.8	-68.6	-57.0	-11.6	Peak	Horizontal
	584.4	-64.1	-57.0	-7.1	Peak	Vertical
	1223.9	-50.5	-47.0	-3.5	Peak	Horizontal
	1482.4	-54.1	-47.0	-7.1	Peak	Vertical
	2128.4	-54.3	-47.0	-7.3	Peak	Horizontal
	1967.9	-53.5	-47.0	-6.5	Peak	Vertical

Note 1: Margin (dB) = Measure Level (dBm) – Limit (dBm).

Note 2: Other frequency was base noise below limit line within 18-26.5GHz, there is not show in the report.

Test Engineer	Milo Li	Temperature	26°C
Test Time	05-20-2015	Relative Humidity	54%
Test Mode	802.11ac-VHT20	Test Site	AC1

Channel	Frequency (MHz)	Measure Level (dBm)	Limit (dBm)	Margin (dB)	Detector	Polarization
149	158.7	-69.7	-57.0	-12.7	Peak	Horizontal
	196.4	-66.5	-57.0	-9.5	Peak	Vertical
	361.2	-68.1	-57.0	-11.1	Peak	Horizontal
	592.8	-64.1	-57.0	-7.1	Peak	Vertical
	2014.0	-57.7	-47.0	-10.7	Peak	Horizontal
	1423.4	-55.0	-47.0	-8.0	Peak	Vertical
	3082.7	-54.3	-47.0	-7.3	Peak	Horizontal
	3044.8	-51.7	-47.0	-4.7	Peak	Vertical
165	473.0	-71.2	-57.0	-14.2	Peak	Horizontal
	377.2	-64.6	-57.0	-7.6	Peak	Vertical
	696.8	-73.4	-57.0	-16.4	Peak	Horizontal
	493.6	-66.0	-57.0	-9.0	Peak	Vertical
	1089.5	-55.4	-47.0	-8.4	Peak	Horizontal
	1474.2	-50.8	-47.0	-3.8	Peak	Vertical
	2078.6	-54.2	-47.0	-7.2	Peak	Horizontal
	1992.3	-55.6	-47.0	-8.6	Peak	Vertical

Note 1: Margin (dB) = Measure Level (dBm) – Limit (dBm).

Note 2: Other frequency was base noise below limit line within 18-26.5GHz, there is not show in the report.

9. Dynamic Frequency Selection (DFS)

Please refer to report number 1612RSU02406-CE-EN302502 DFS Report.

10. Measurement Uncertainty

Where relevant, the following measurement uncertainty levels have been estimated for tests performed on the apparatus:

Parameter	Uncertainty
Radio Frequency	$\pm 1 \times 10^{-5}$
RF output power, conducted	± 1.5 dB
Power Spectral Density, conducted	± 3 dB
Temperature	± 1 °C
Humidity	± 5 %
DC and low frequency voltages	± 3 %
Time	± 5 %
Duty Cycle	± 5 %

11. Test Photograph

Description: Radiated Spurious Emissions Test Setup for Below 1GHz

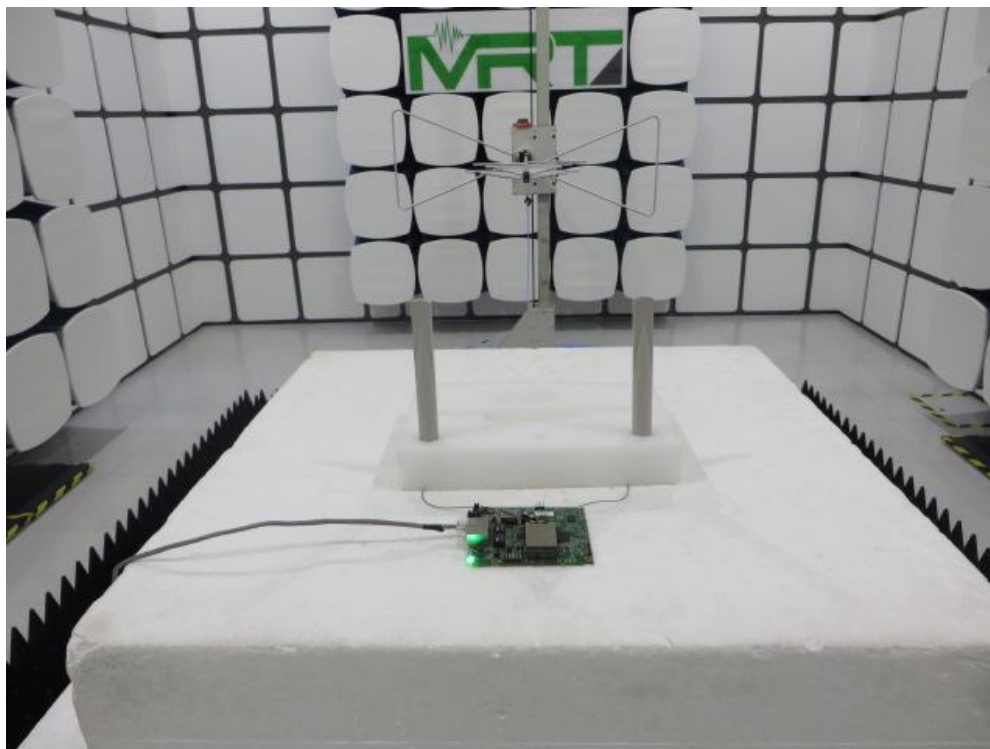

Description: Radiated Spurious Emissions Test Setup for Above 1GHz

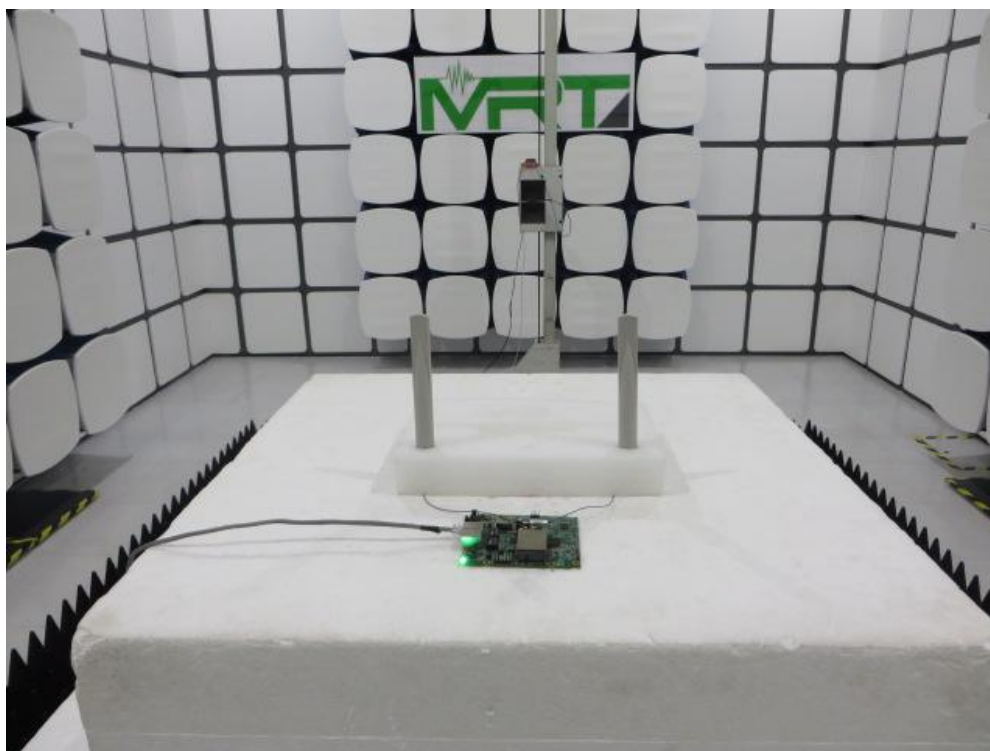

Description: Radiated Spurious Emissions Test Setup for 18 - 40GHz

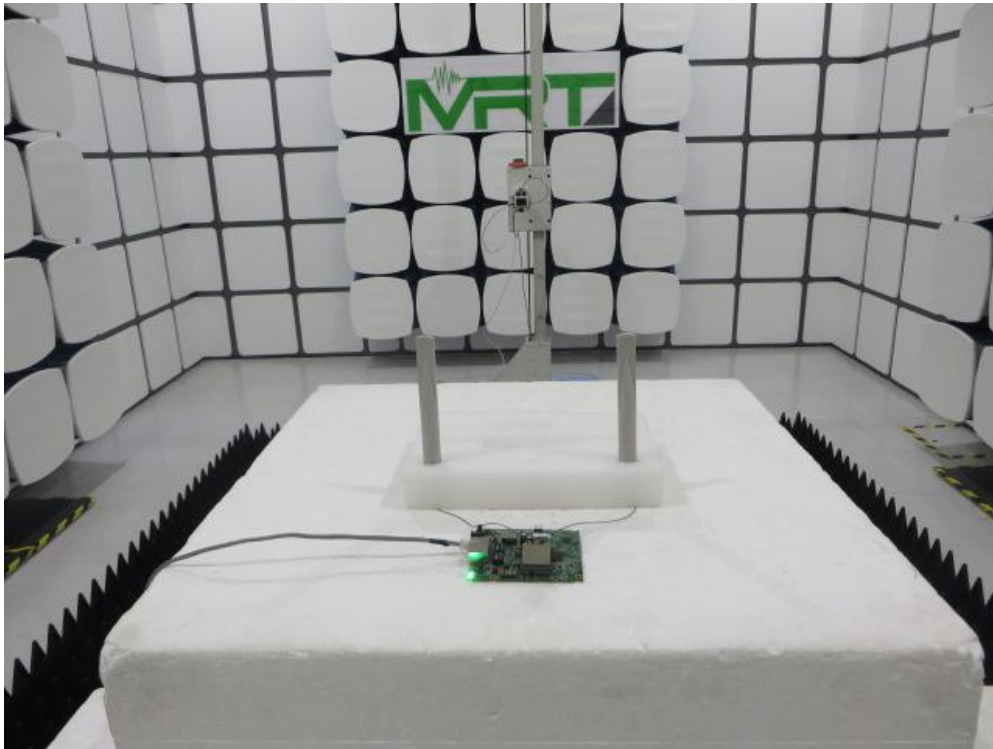

Description: Radiated Spurious Emissions Test Setup for Below 1GHz

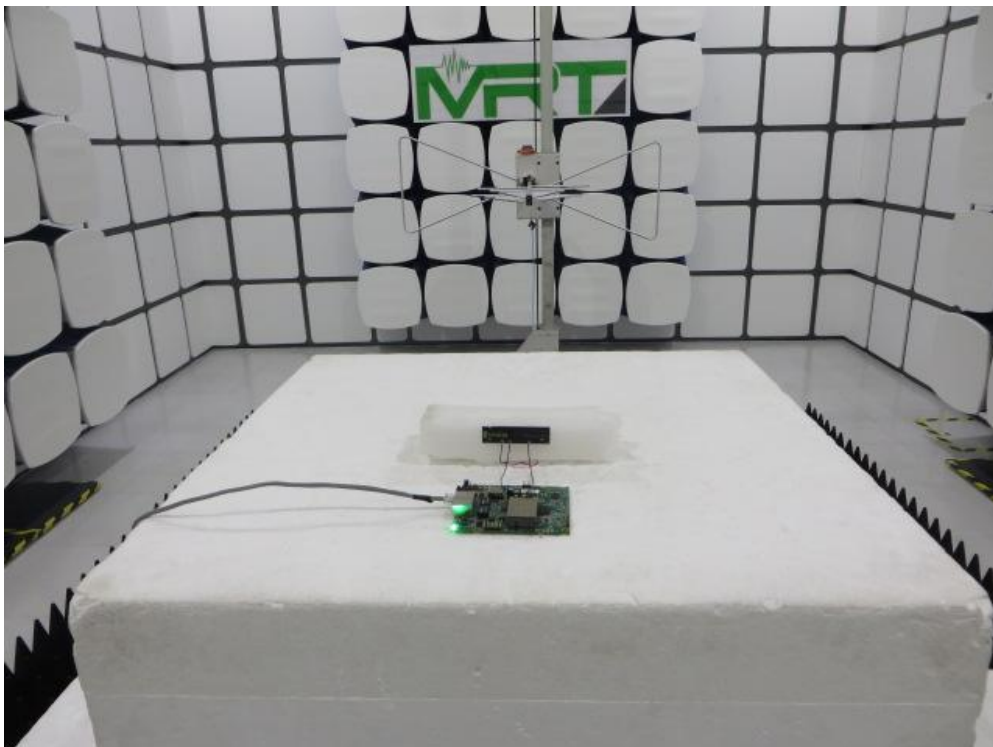

Description: Radiated Spurious Emissions Test Setup for Above 1GHz

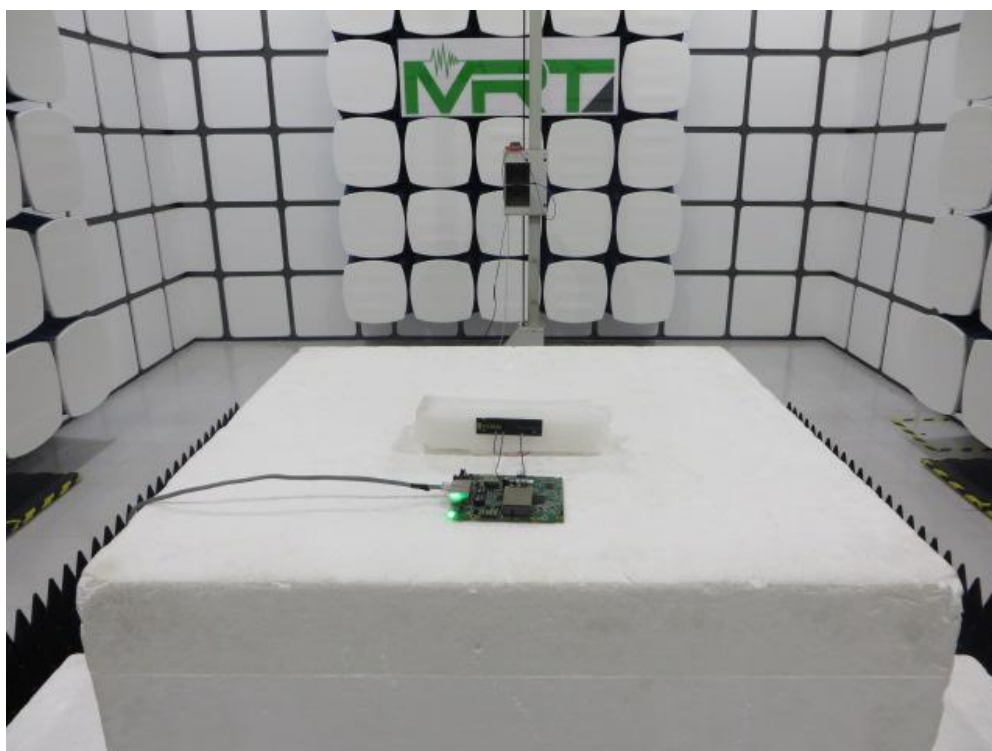

Description: Radiated Spurious Emissions Test Setup for 18 - 40GHz

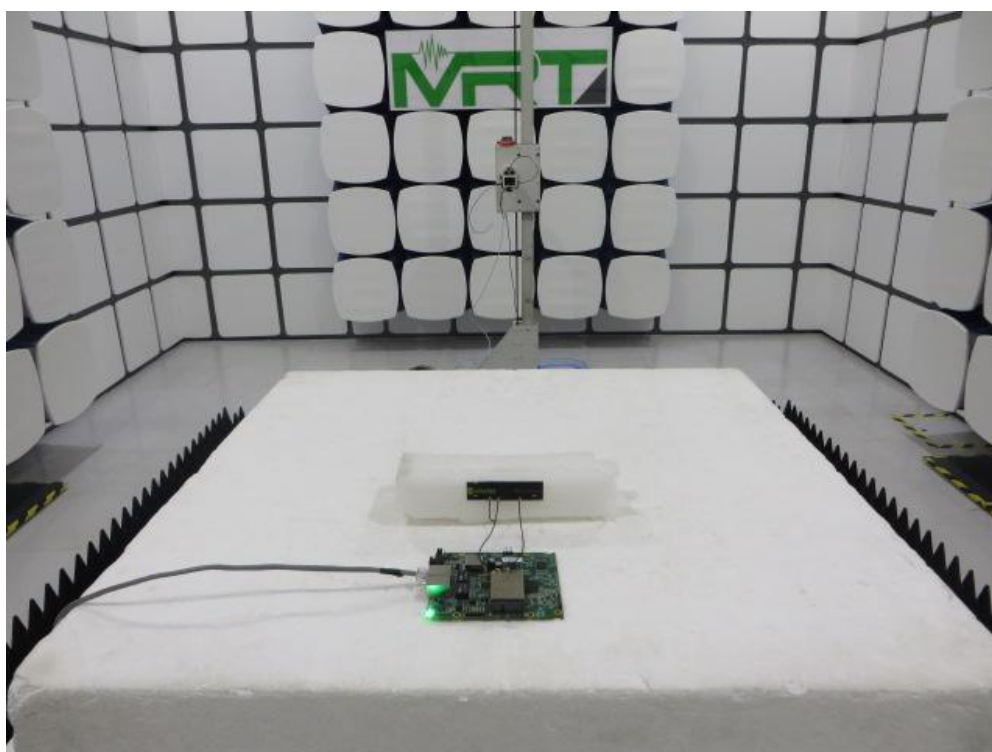

12. List of Measuring Instrument

Carrier Frequencies

Instrument	Manufacturer	Type No.	Cali. Interval	Cali. Due Date
Spectrum Analyzer	Agilent	N9020A	1 year	2016/04/23
Programmable Temperature & Humidity Chamber	BAOYT	BYH-1500L	1 year	2015/12/10
Temperature/Humidity Meter	Anymetre	TH101B	1 year	2015/11/15

RF Output Power, Transmit Power Control (TPC) and Power Density

Instrument	Manufacturer	Type No.	Cali. Interval	Cali. Due Date
Power Meter	Agilent	U2021XA	1 year	2015/12/09
Programmable Temperature & Humidity Chamber	BAOYT	BYH-1500L	1 year	2015/12/10
Temperature/Humidity Meter	Anymetre	TH101B	1 year	2015/11/15

Transmitter Unwanted Emissions Within the 5GHz RLAN Bands

Instrument	Manufacturer	Type No.	Cali. Interval	Cali. Due Date
Spectrum Analyzer	Agilent	E4447A	1 year	2015/12/09
Temperature/Humidity Meter	Anymetre	TH101B	1 year	2015/11/15

Transmitter Spurious Emissions and Receiver Spurious Emissions

Instrument	Manufacturer	Type No.	Cali. Interval	Cal. Due Date
Spectrum Analyzer	Agilent	E4447A	1 year	2015/12/09
Preamplifier	MRT	AP25M01	1 year	2015/10/06
Preamplifier	Agilent	83017A	1 year	2015/12/13
Bilog Period Antenna	Schwarzbeck	VULB 9162	1 year	2015/11/08
Broadband Horn Antenna	Schwarzbeck	BBHA9120D	1 year	2015/11/08
Horn Antenna	Schwarzbeck	BBHA9170	1 year	2015/12/11
Temperature/Humidity Meter	Anymetre	TH101B	1 year	2015/11/15

Software	Version	Function
e3	V8.3.5	EMI Test Software

13. Appendix - EUT Photograph

(1) EUT Photo

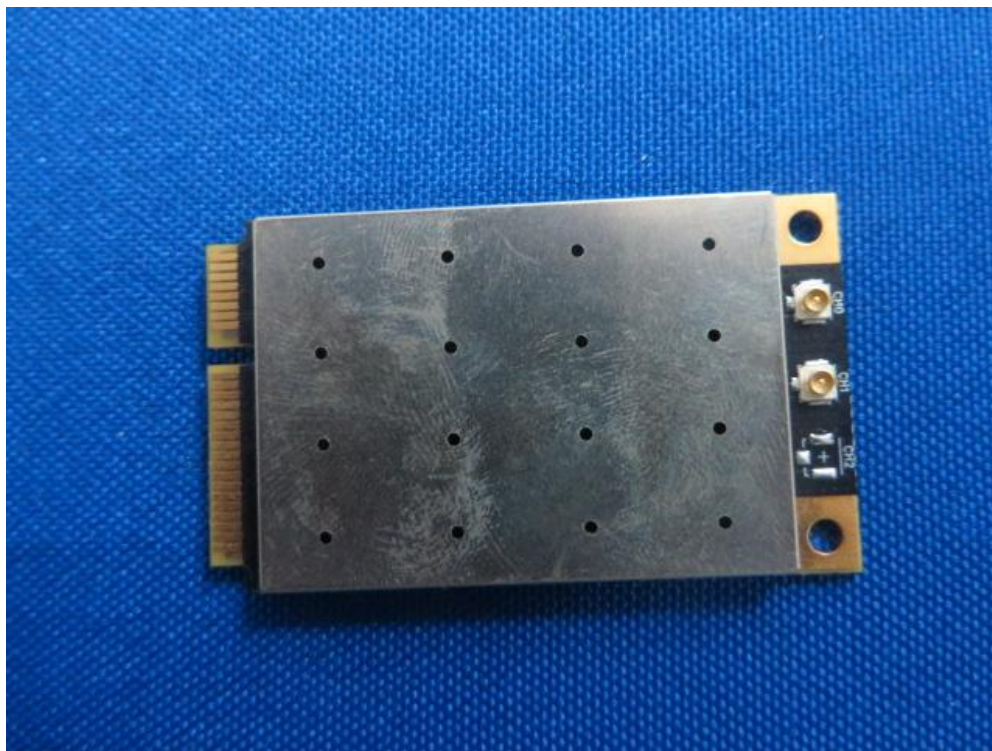

(2) EUT Photo

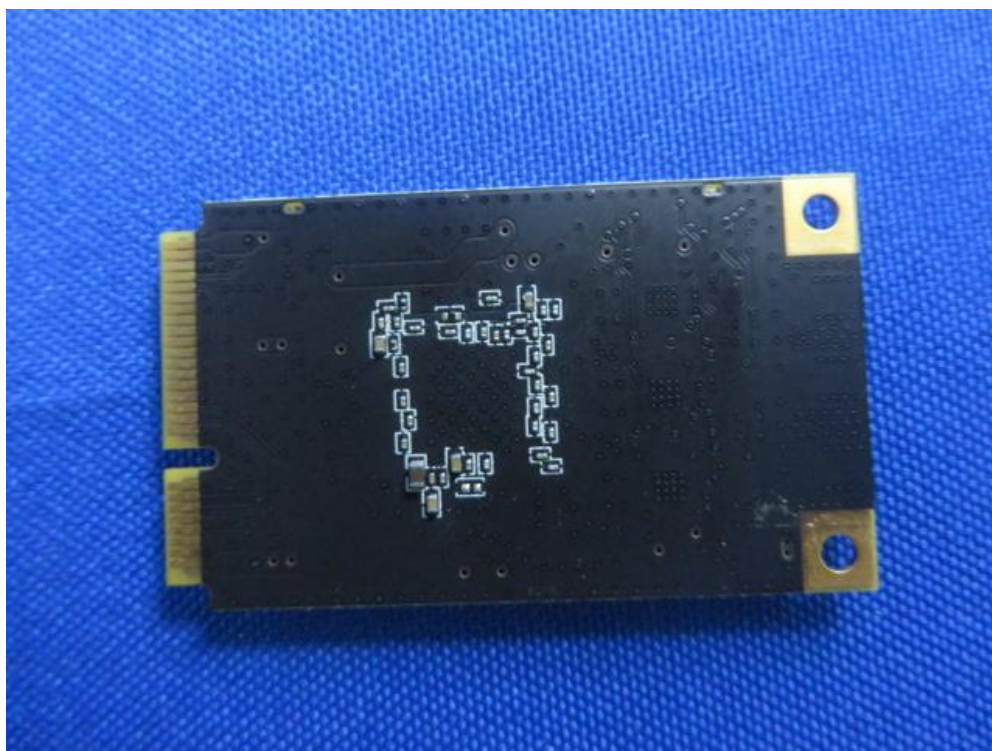

(3) EUT Photo



(4) EUT Photo



(5) EUT Photo

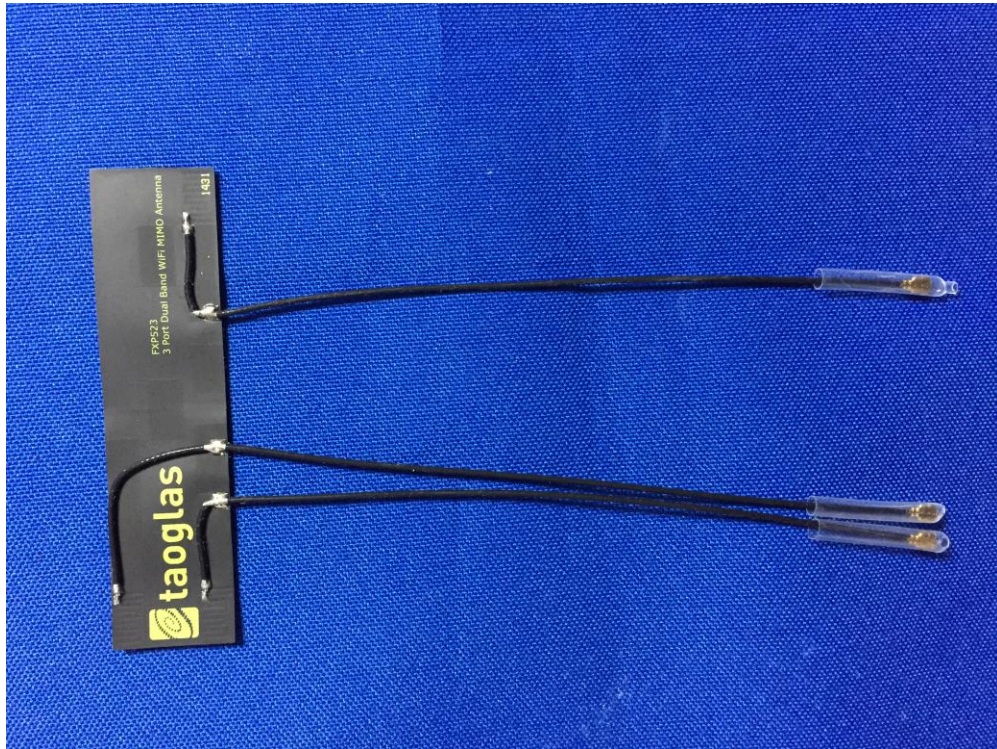

(6) EUT Photo

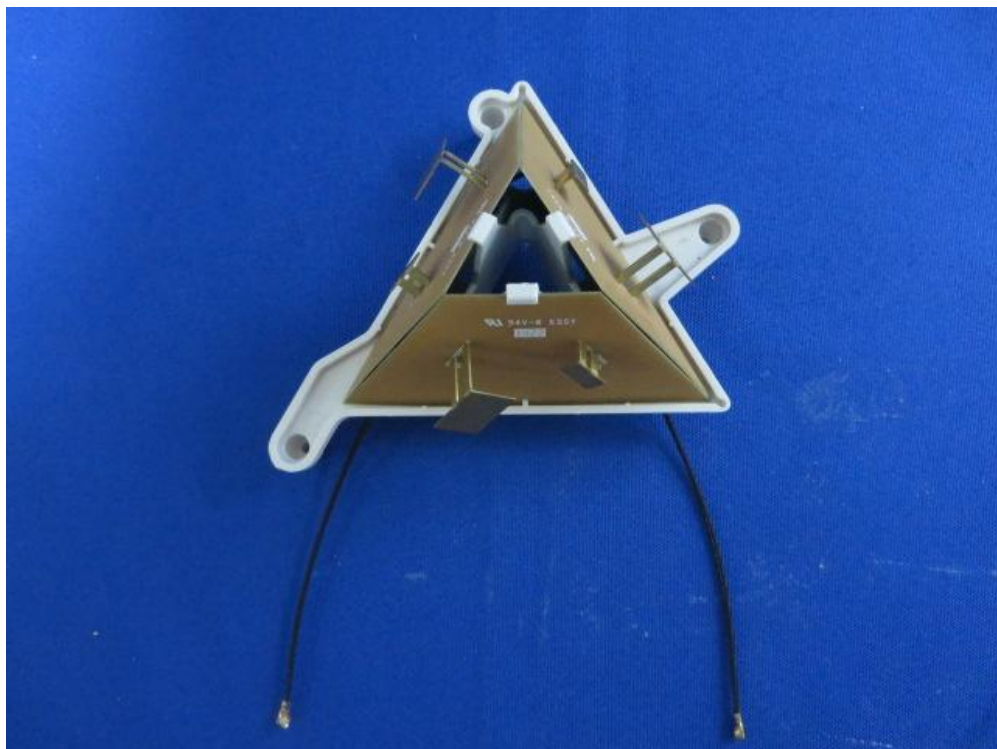

(7) EUT Photo

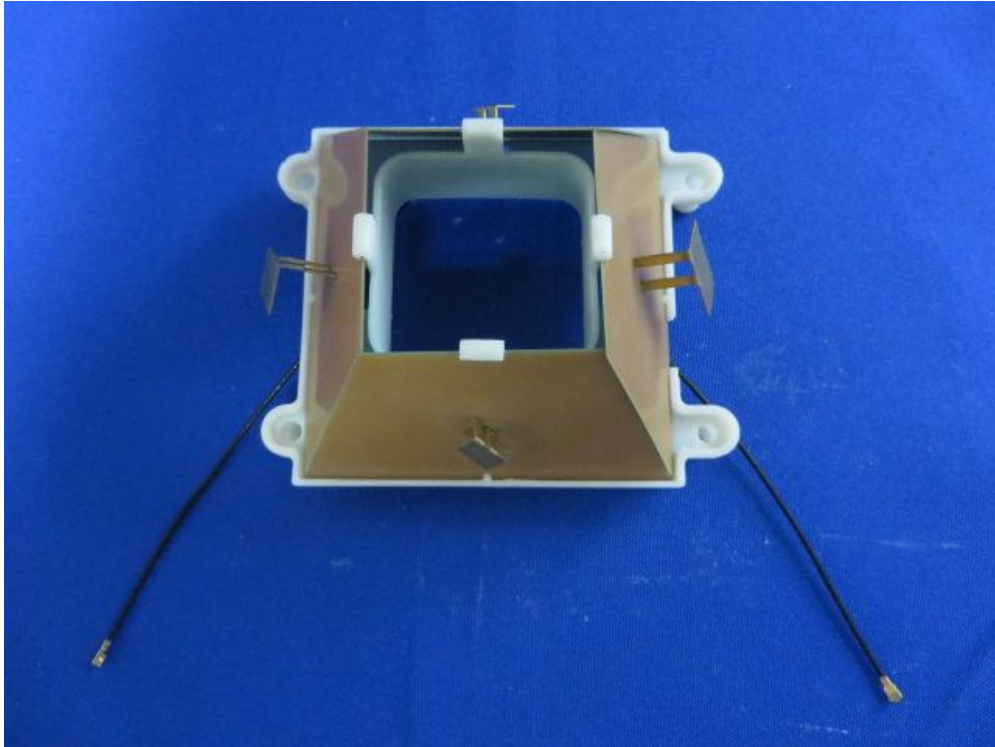

(8) EUT Photo



(9) EUT Photo

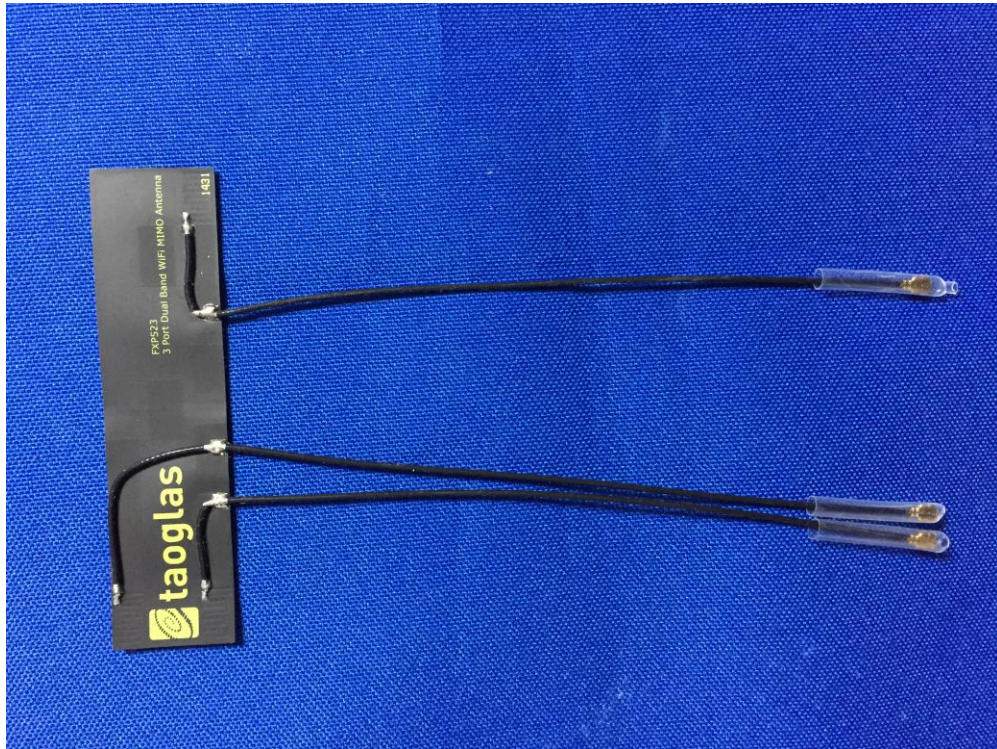

The End